

Accurate *Weight*

Perfect, Because of Accurate.



常州艾克瑞特衡器有限公司

CHANGZHOU ACCURATE WEIGHT CO.,LTD

www.accurate.cc



PROFESSIONAL MANUFACTURE OF RELIABLE AND HIGH QUALITY WEIGHTS IN THE WORDWIDE.

Product

Over many decades experience of leading and professional on calibration weights, today Accurate as the top manufacture of precision weights and masses in China.

1mg
TO
5000kg

Make all types of weights from 1mg to 5000kg in class E1 to M2 .

Professional manufacture in develop and design Auto-load test scales machines, now our testing machines help myriad scales and balances factories to greatly improve their production efficiency in domestic and abroad countries.



Quality Guarantee

As quality is the key and root, at Accurate, to keep and guarantee the top quality in every process. From first step raw material, we strictly require and take particular care in selecting the raw material: density, magnetization and magnetic susceptibility.

In every production step, our employees checked with extremely accuracy scales as calibrated standard weights.

The most authoritative measurement institute: National Institute of Metrology (NIM) is the national metrology institute (NMI) of China, the nation's highest technical authoritative institute in the field of metrology, our standard weights get certificate from NIM. In our laboratory, import the most advanced testing equipment of comparators, help ensure measuring and extremely high precision result.



Market Recognition

Today, with the electronic developed, weights are no longer the traditional sense weights, it's role more important and extra even in everywhere of life. Including laboratory, industry, chemicals, pharmaceuticals, mechanics, education etc..



公司简介:

我司专业生产OIML/ASTM 标准砝码、各类定制砝码及衡器自动化检测设备。公司拥有全套世界顶级砝码生产、校准设备，独立研发部门，目前已取得20多项专利。

设计制造的衡器检测设备，适用于电子天平、桌秤、台秤、小地磅、吊钩秤、健康秤、传感器等各类衡器的自动化检测，极大地降低了劳动强度，提高生产效率，更好地保证检测结果的完整性及准确性。



目标 Goal

成为行业最具竞争力的标准砝码、衡器自动化检测设备的生产企业。



品质保证:

从原材料的定制采购开始到生产上的每个环节，我们都严格检验，以确保砝码的密度、磁化率及砝码精准度。

生产流程:

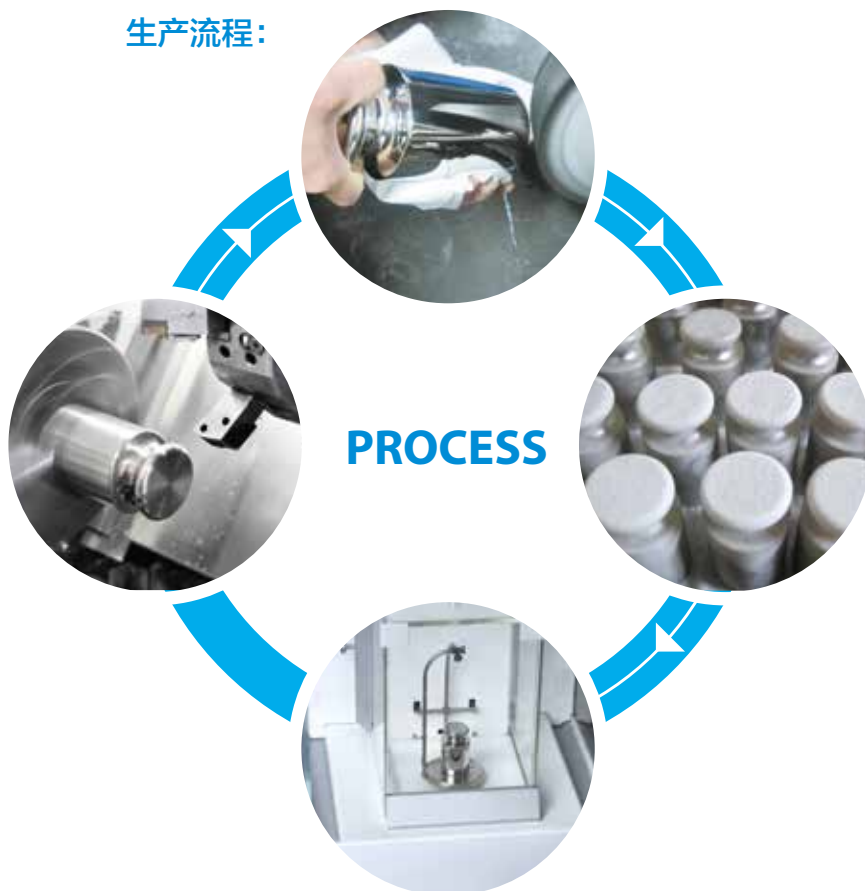

客户群体:

天平、衡器制造企业；计量机构；仪器、仪表经销商；食品、药品、化工、军工、学校及实验室等各类行业。



HOW TO CHOOSE NECESSARY WEIGHT YOU NEED

砝码选择标准

Maximum Susceptibility, χ

最大磁化率

Weight class 砝码等级	E1	E2	F1	F2
$m \leq 1g$	0.25	0.9	10	—
$2g \leq m \leq 10g$	0.06	0.18	0.7	4
$20g \leq m$	0.02	0.07	0.2	0.8



Maximum Polarization, $\mu_0 M, (\mu T)$

最大极化强度

Weight class 砝码等级	E1	E2	F1	F2	M1	M1-2	M2	M2-3	M3	
Maximum polarization 最大极化强度	2.5	8	25	80	250	500	800	1600	2500	
	A/m	2	6.4	20	64	200	400	640	1280	2000

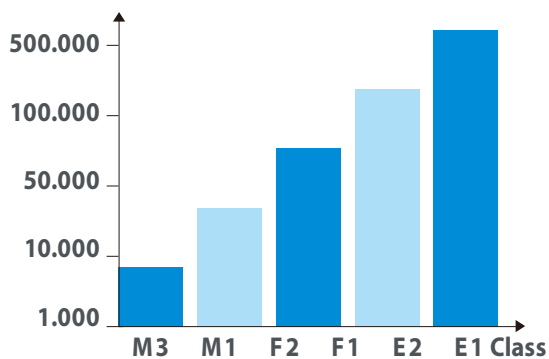

Weight intervals n 检定分度数 n	Max. load capacity 最大称量	Scale interval d 检定分度值
IV Ordinary accuracy scale	$\leq 1.000d$	Class M3
III Medium accuracy scale	$\leq 10.000d$	Class M1
II Precision balance	$\leq 30.000d$	Class F2
I Analytical balance	$\leq 100.000d$	Class F1
	$\leq 100.000d$	Class E2

Density of Weights Material

材料密度表

	Density 密度	Density uncertainty 允许误差
	kg/m ³	kg/m ³
	U(k=2)	
High Quality Stainless Steel 高品质不锈钢	8000	±80
Non-magnetic stainless steel 无磁不锈钢	7950	±100
Stainless Steel 不锈钢	7900	±140
Steel 钢	7850	±200
Cast Iron 铸铁	7200	±400
Aluminium 铝	2700	±120
Brass 铜	8500	±100

Minimum and Maximum limits for Density (ρ_{min}, ρ_{max})

密度的最小和最大极限值

	$\rho_{min}, \rho_{max} (10^3 kg/m^3)$								
	Class of weight (for class M3, no value is specified) 砝码等级 (对M3等级砝码没有指标要求)								
	E1	E2	F1	F2	M1	M12	M2	M23	M3
$\geq 100g$	7.934-8.067	7.81-8.21	7.39-8.73	6.4-10.7	≥ 4.4	> 3.0	≥ 2.3	≥ 1.5	
50g	7.92-8.08	7.74-8.28	7.27-8.89	6.0-12.0	≥ 4.0				
20g	7.84-8.17	7.50-8.57	6.6-10.1	4.8-24.0	≥ 2.6				
10g	7.74-8.28	7.27-8.89	6.0-12.0	≥ 4.0	≥ 2.0				
5g	7.62-8.42	6.9-9.6	5.3-16.0	≥ 3.0					
2g	7.27-8.89	6.0-12.0	≥ 4.0	≥ 2.0					
1g	6.9-9.6	5.3-16.0	≥ 3.0						
500mg	6.3-10.9	≥ 4.4	≥ 2.2						
200mg	5.3-16.0	≥ 3.0							
100mg	≥ 4.4								
50mg	≥ 3.4								
20mg	≥ 2.3								

OIML R111-2004 Tolerance ±mg

砝码最大允许误差的绝对值

Denomination	E1	E2	F1	F2	M1	M2
5000kg			25000	80000	250000	800000
2000kg			10000	30000	100000	300000
1000kg		1600	5000	16000	50000	160000
500kg		800	2500	8000	25000	80000
200kg		300	1000	3000	10000	30000
100kg		160	500	1600	5000	16000
50kg	25	80	250	800	2500	8000
20kg	10	30	100	300	1000	3000
10kg	5	16	50	160	500	1600
5kg	2.5	8.0	25	80	250	800
2kg	1	3.0	10	30	100	300
1kg	0.5	1.6	5.0	16	50	160
500g	0.25	0.8	2.5	8.0	25	80
200g	0.1	0.3	1.0	3.0	10	30
100g	0.05	0.16	0.5	1.6	5.0	16
50g	0.03	0.10	0.3	1.0	3.0	10
20g	0.025	0.08	0.25	0.8	2.5	8.0
10g	0.020	0.06	0.20	0.6	2.0	6.0
5g	0.016	0.05	0.16	0.5	1.6	5.0
2g	0.012	0.04	0.12	0.4	1.2	4.0
1g	0.010	0.03	0.10	0.3	1.0	3.0
500mg	0.008	0.025	0.08	0.25	0.8	2.5
200mg	0.006	0.020	0.06	0.20	0.6	2.0
100mg	0.005	0.016	0.05	0.16	0.5	1.6
50mg	0.004	0.012	0.04	0.12	0.4	
20mg	0.003	0.010	0.03	0.10	0.3	
10mg	0.003	0.008	0.025	0.08	0.25	
5mg	0.003	0.006	0.020	0.06	0.20	
2mg	0.003	0.006	0.020	0.06	0.20	
1mg	0.003	0.006	0.020	0.06	0.20	

ASTM E617 Tolerance ±mg

砝码最大允许误差的绝对值

Denomination	Class 0	Class 1	Class 2	Class 3	Class 4	Class 5	Class 6	Class 7
5000kg					100g	250g	500g	750g
3000kg					60g	150g	300g	450g
2000kg					40g	100g	200g	300g
1000kg					20g	50g	100g	150g
500kg					10g	25g	50g	75g
300kg					6.0g	15g	30g	45g
200kg					4.0g	10g	20g	30g
100kg					2.0g	5g	10g	15g
50kg	63	125	250	500	1.0g	2.5g	5g	7.5g
30kg	38	75	150	300	600	1.5g	3g	4.5g
25kg	31	62	125	250	500	1.2g	2.5g	4.5g
20kg	25	50	100	200	400	1.0g	2g	3.8g
10kg	13	25	50	100	200	500	1g	2.2g
5 kg	6	12	25	50	100	250	500	1.4g
3 kg	3.8	7.5	15	30	60	150	300	1.0g
2 kg	2.5	5	10	20	40	100	200	750
1 kg	1.3	2.5	5.0	10	20	50	100	470
500 g	0.60	1.2	2.5	5.0	10	30	50	300
300 g	0.38	0.75	1.5	3.0	6.0	20	30	210
200 g	0.25	0.5	1.0	2.0	4.0	15	20	160
100 g	0.13	0.25	0.50	1.0	2.0	9	10	100
50 g	0.060	0.12	0.25	0.60	1.2	5.6	7	...
30 g	0.037	0.074	0.15	0.45	0.90	4.0	5	44
20 g	0.037	0.074	0.10	0.35	0.70	3.0	3	33
10 g	0.025	0.050	0.074	0.25	0.50	2.0	2	21
5 g	0.017	0.034	0.054	0.18	0.36	1.3	2	13
3g	0.017	0.034	0.054	0.15	0.30	0.95	2	9.4
2 g	0.017	0.034	0.054	0.13	0.26	0.75	2	7.0
1 g	0.017	0.034	0.054	0.10	0.20	0.50	2	4.5
500 mg	0.005	0.010	0.025	0.080	0.16	0.38	1	3.0
300 mg	0.005	0.010	0.025	0.070	0.14	0.30	1	2.2
200 mg	0.005	0.010	0.025	0.060	0.12	0.26	1	1.8
100 mg	0.005	0.010	0.025	0.050	0.10	0.20	1	1.2
50 mg	0.005	0.010	0.014	0.042	0.085	0.16	0.50	0.88
30 mg	0.005	0.010	0.014	0.038	0.075	0.14	0.50	0.68
20 mg	0.005	0.010	0.014	0.035	0.070	0.12	0.50	0.56
10 mg	0.005	0.010	0.014	0.030	0.060	0.10	0.50	0.4
5 mg	0.005	0.010	0.014	0.028	0.055	0.080	0.20	...
3 mg	0.005	0.010	0.014	0.026	0.052	0.070	0.20	...
2 mg	0.005	0.010	0.014	0.025	0.050	0.060	0.20	...
1 mg	0.005	0.010	0.014	0.025	0.050	0.050	0.10	...



COMPOSITION OF THE STANDARD WEIGHT SETS

套装砝码组合

Weights Set

	1-500mg	1mg-100g	1mg-200g	1mg-500g	1mg-1kg	1mg-2kg	1kg-5kg	1mg-5kg	1mg-10kg	1mg-20kg
1mg	▲	▲	▲	▲	▲	▲		▲	▲	▲
2mg	■	■	■	■	■	■		■	■	■
5mg	▼	▼	▼	▼	▼	▼		▼	▼	▼
10mg	▽	▽	▽	▽	▽	▽		▽	▽	▽
20mg	■	■	■	■	■	■		■	■	■
50mg	◆	◆	◆	◆	◆	◆		◆	◆	◆
100mg	▽	▽	▽	▽	▽	▽		▽	▽	▽
200mg	■	■	■	■	■	■		■	■	■
500mg	◆	◆	◆	◆	◆	◆		◆	◆	◆
1g		■	■	■	■	■		■	■	■
2g		■	■	■	■	■		■	■	■
5g		■	■	■	■	■		■	■	■
10g		■	■	■	■	■		■	■	■
20g		■	■	■	■	■		■	■	■
50g		■	■	■	■	■		■	■	■
100g		■	■	■	■	■		■	■	■
200g			■	■	■	■		■	■	■
500g				■	■	■		■	■	■
1kg					■	■	■	■	■	■
2kg						■	■	■	■	■
5kg							■	■	■	■
10kg									■	■
20kg										■
Quantity (pcs) 数量共计	12	21	23	24	25	27	4	28	29	30



Index

目录

	E1 CLASS Stainless Steel 不锈钢	07-08
	E2 CLASS Stainless steel 不锈钢	09-11
	F1 CLASS Stainless Steel 不锈钢	12-18
	F2 CLASS Stainless Steel 不锈钢	19-23
	M1 CLASS Stainless Steel Chromed Steel Brass Surface Cast Iron 不锈钢 钢制镀铬 铜质烤漆 铸铁砝码	24-36
	ACCESSORIES 附件	37
	MACHINE Body Scale Auto-load Testing Machine Counting Scale Auto-load Testing Machine Platform Scale Auto-load Testing Machine Hook Scale Auto-load Testing Machine Floor Scale Auto-load Testing Machine Medical Chair Scale Auto-load Testing Machine Forklift Truck Scale Auto-load Testing Machine Load Cell Creep Auto-load Testing Machine Load Cell Four Corners Auto-load Testing Machine Comparator Auto-load Testing Machine Auto-load Move Weight Machine Baby Scale Auto-load Testing Machine Postal Parcel Scale Auto-load Testing Machine Electrical Balance Auto-load Testing Machine Fatigue Auto-load Testing Machine 人体秤标定机 桌秤标定机 台秤标定机 吊钩秤标定机 小地磅标定机 轮椅秤标定机 叉车秤标定机 传感器蠕变测试机 传感器四角标定机 比较仪用砝码机械手 砝码搬运助力臂 婴儿秤标定机 邮包秤标定机 电子天平标定机 疲劳测试机	38-46

CLASS

E1



Weight
砝码

Solid Weight

实心砝码



Shape
形状

1mg-500mg

Flat Polygonal Sheets

■ 片状

1g-20kg

Knob Weight

■ 圆柱体

Packing
包装

Individual:
Aluminum Case

单只: 高品质铝箱

Weight Set:
Aluminum Case

套装: 高品质铝箱

■ Individual Weight
单只包装

■ 1mg-5g ABS Box
1mg-5g 塑盒装

■ Weight Set
套装



High Quality Stainless Steel

高品质不锈钢



E1 Individual

E1等级单只

Nominal Value 规格	Tolerance 允差	Serial No. 订货代码	Package Size (LxWxH) 包装尺寸 (LxWxH)	Weight (With Packaging) 含包装重量
	(mg)	High Quality Aluminum Case 高品质铝箱	mm	kg
1mg	0.003	12200010	80x80x110	0.2
2mg	0.003	12200011	80x80x110	0.2
5mg	0.003	12200012	80x80x110	0.2
10mg	0.003	12200013	80x80x110	0.2
20mg	0.003	12200014	80x80x110	0.2
50mg	0.004	12200015	80x80x110	0.2
100mg	0.005	12200016	80x80x110	0.2
200mg	0.006	12200017	80x80x110	0.2
500mg	0.008	12200018	80x80x110	0.2
1g	0.01	12200020	80x80x110	0.21
2g	0.012	12200021	80x80x110	0.21
5g	0.016	12200022	80x80x110	0.21
10g	0.02	12200023	80x80x110	0.21
20g	0.025	12200024	80x80x110	0.22
50g	0.03	12200025	80x80x110	0.25
100g	0.05	12200026	80x80x110	0.3
200g	0.1	12200027	80x80x110	0.4
500g	0.25	12200028	80x80x110	0.7
1kg	0.5	12200030	80x80x110	1.2
2kg	1	12200031	90x90x135	2.3
5kg	2.5	12200032	140x140x180	5.8
10kg	5	12200033	155x155x240	11.4
20kg	10	12200034	190x190x285	22

E1 Weights Set

E1等级套装

Nominal Value 规格	Serial No. 订货代码	Quantity 数量	Measuring Range 量程	Package Size (LxWxH) 包装尺寸 (LxWxH)	Weight (With Aluminum Case) 含包装重量	Stainless Steel Tweezer 不锈钢镊子
	(Aluminum Case)	Pcs/Set	g	mm	kg	pc
1mg-500mg	12200080	12	1.11g	170x140x70	0.53	1
1mg-100g	12200081	21	211.11g	170x130x80	0.83	1
1mg-200g	12200082	23	611.11g	210x140x100	1.62	1
1mg-500g	12200083	24	1111.11g	210x140x100	2.12	1
1mg-1kg	12200084	25	2111.11g	270x150x110	3.54	1
1mg-2kg	12200085	27	6111.11g	280x210x130	7.97	1
1kg-5kg	12200086	4	10000.00g			1
1mg-5kg	12200087	28	11111.11g			1
1mg-10kg	12200088	29	21111.11g			1
1mg-20kg	12200089	30	41111.11g			1

CLASS

E2



Weight
砝码

Solid Weight

实心砝码



Shape
形状

1mg-500mg

Flat Polygonal Sheets

■ 片状

1g-20kg

Knob Weight

■ 圆柱体

Packing
包装

Individual:
ABS Box / Aluminum Case
单只: 塑盒 / 高品质铝箱

Weight Set:
Aluminum Case
套装: 高品质铝箱

■ ■ Individual Weight
单只包装

■ 1mg-5g ABS Box
1mg-5g 塑盒装

■ Weight Set
套装



High Quality Stainless Steel 高品质不锈钢



Knob Solid Weight 实心圆柱体砝码

Nominal Value 规格	Tolerance 允差	Serial No. 订货代码	Package Size 包装尺寸(Φ×h)	Weight(With Packaging) 含包装重量	Serial No. 订货代码	Package Size 包装尺寸(LxWxH)	Weight(With Packaging) 含包装重量
	(mg)	ABS Box 塑盒	mm	kg	Aluminum Case 铝箱	mm	kg
1mg	0.006	11300010	39×56	0.02	12300010	80x80x110	0.2
2mg	0.006	11300011	39×56	0.02	12300011	80x80x110	0.2
5mg	0.006	11300012	39×56	0.02	12300012	80x80x110	0.2
10mg	0.008	11300013	39×56	0.02	12300013	80x80x110	0.2
20mg	0.010	11300014	39×56	0.02	12300014	80x80x110	0.2
50mg	0.012	11300015	39×56	0.02	12300015	80x80x110	0.2
100mg	0.016	11300016	39×56	0.02	12300016	80x80x110	0.2
200mg	0.020	11300017	39×56	0.02	12300017	80x80x110	0.2
500mg	0.025	11300018	39×56	0.02	12300018	80x80x110	0.2
1g	0.03	11300020	39×56	0.021	12300020	80x80x110	0.21
2g	0.04	11300021	39×56	0.022	12300021	80x80x110	0.21
5g	0.05	11300022	39×56	0.025	12300022	80x80x110	0.21
10g	0.06	11300023	39×56	0.03	12300023	80x80x110	0.21
20g	0.08	11300024	39×56	0.04	12300024	80x80x110	0.22
50g	0.10	11300025	39×56	0.07	12300025	80x80x110	0.25
100g	0.16	11300026	39×56	0.12	12300026	80x80x110	0.3
200g	0.3	11300027	45×66	0.23	12300027	80x80x110	0.4
500g	0.8	11300028	57×84	0.56	12300028	80x80x110	0.7
1kg	1.6	11300030	67×111	1.1	12300030	80x80x110	1.2
2kg	3.0	11300031	95×135	2.2	12300031	90x90x135	2.3
5kg	8.0	11300032	116×178	5.4	12300032	140x140x180	5.8
10kg	16	11300033	159×300	11.2	12300033	155x155x240	11.4
20kg	30	11300034	187×350	21.6	12300034	190x190x285	22

Weight Set 套装

Nominal Value 规格	Serial No. 订货代码	Quantity 数量	Measuring Range 量程	Package Size 包装尺寸(LxWxH)	Weight(With Packaging) 含包装重量	Stainless Steel Tweezer 不锈钢镊子
	Aluminum Case 铝箱	Pcs/Set 只/套	g	mm	kg	pc
12300080	1mg-500mg	12	1.11g	170x140x70	0.53	1
12300081	1mg-100g	21	211.11g	170x130x80	0.83	1
12300082	1mg-200g	23	611.11g	210x140x100	1.62	1
12300083	1mg-500g	24	1111.11g	210x140x100	2.12	1
12300084	1mg-1kg	25	2111.11g	270x150x110	3.54	1
12300085	1mg-2kg	27	6111.11g	280x210x130	7.97	1
12300086	1kg-5kg	4	10000.00g			1
12300087	1mg-5kg	28	11111.11g			1
12300088	1mg-10kg	29	21111.11g			1
12300089	1mg-20kg	30	41111.11g			1

Non-Magnetic Stainless Steel 无磁不锈钢



Knob Solid Weight 实心圆柱体砝码

Nominal Value 规格	Tolerance 允差	Serial No. 订货代码	Package Size 包装尺寸(Φ×h)	Weight(With Packaging) 含包装重量	Serial No. 订货代码	Package Size 包装尺寸(L×W×H)	Weight(With Packaging) 含包装重量
	(mg)	ABS Box 塑盒	mm	kg	Aluminum Case 铝箱	mm	kg
1mg	0.006	11310010	39×56	0.02	12310010	80×80×110	0.2
2mg	0.006	11310011	39×56	0.02	12310011	80×80×110	0.2
5mg	0.006	11310012	39×56	0.02	12310012	80×80×110	0.2
10mg	0.008	11310013	39×56	0.02	12310013	80×80×110	0.2
20mg	0.010	11310014	39×56	0.02	12310014	80×80×110	0.2
50mg	0.012	11310015	39×56	0.02	12310015	80×80×110	0.2
100mg	0.016	11310016	39×56	0.02	12310016	80×80×110	0.2
200mg	0.020	11310017	39×56	0.02	12310017	80×80×110	0.2
500mg	0.025	11310018	39×56	0.02	12310018	80×80×110	0.2
1g	0.03	11310020	39×56	0.021	12310020	80×80×110	0.21
2g	0.04	11310021	39×56	0.022	12310021	80×80×110	0.21
5g	0.05	11310022	39×56	0.025	12310022	80×80×110	0.21
10g	0.06	11310023	39×56	0.03	12310023	80×80×110	0.21
20g	0.08	11310024	39×56	0.04	12310024	80×80×110	0.22
50g	0.10	11310025	39×56	0.07	12310025	80×80×110	0.25
100g	0.16	11310026	39×56	0.12	12310026	80×80×110	0.3
200g	0.3	11310027	45×66	0.23	12310027	80×80×110	0.4
500g	0.8	11310028	57×84	0.56	12310028	80×80×110	0.7
1kg	1.6	11310030	67×111	1.1	12310030	80×80×110	1.2
2kg	3.0	11310031	95×135	2.2	12310031	90×90×135	2.3
5kg	8.0	11310032	116×178	5.4	12310032	140×140×180	5.8
10kg	16	11310033	159×300	11.2	12310033	155×155×240	11.4
20kg	30	11310034	187×350	21.6	12310034	190×190×285	22

Weight Set 套装

Nominal Value 规格	Serial No. 订货代码	Quantity 数量	Measuring Range 量程	Package Size 包装尺寸(L×W×H)	Weight(With Packaging) 含包装重量	Stainless Steel Tweezer 不锈钢镊子
	Aluminum Case 铝箱	Pcs/Set 只/套	g	mm	kg	pc
1mg-500mg	12310080	12	1.11g	170×140×70	0.53	1
1mg-100g	12310081	21	211.11g	170×130×80	0.83	1
1mg-200g	12310082	23	611.11g	210×140×100	1.62	1
1mg-500g	12310083	24	1111.11g	210×140×100	2.12	1
1mg-1kg	12310084	25	2111.11g	270×150×110	3.54	1
1mg-2kg	12310085	27	6111.11g	280×210×130	7.97	1
1kg-5kg	12310086	4	10000.00g			1
1mg-5kg	12310087	28	11111.11g			1
1mg-10kg	12310088	29	21111.11g			1
1mg-20kg	12310089	30	41111.11g			1

CLASS

F1



Weight 砝码

1mg-20g

Solid
实心砝码

50g-20kg

Solid/ Adjustment Cavity
实心/调整腔

 Solid Weight
实心砝码

 Bottom Adjustment
底部调整

 Top Adjustment
顶部调整

 Neck Adjustment
颈部调整

Shape 形状

1mg-500mg

Flat Polygonal Sheets
片状

1g-20kg

Knob Weight
圆柱体

1kg-20kg

Rectangular shape
锁型

Packing 包装

Individual:
ABS Box / Aluminum Case
单只: 塑盒/ 铝箱

Weight Set:
Aluminum Case
套装: 铝箱

 Individual Weight
单只包装

 1mg-500mg
1mg-500mg套装

 Weight Set
套装



Non-Magnetic Stainless Steel 无磁不锈钢



Knob Solid Weight 圆柱形实心砝码

Nominal Value 规格	Tolerance 允差	Serial No. 订货代码	Package Size 包装尺寸(Φ×h)	Weight(With Packaging) 含包装重量	Serial No. 订货代码	Package Size 包装尺寸(LxWxH)	Weight(With Packaging) 含包装重量
	(mg)	ABS Box 塑盒	mm	kg	Aluminum Case 铝箱	mm	kg
1mg	0.020	11410010	39×56	0.02	12410010	80×80×110	0.2
2mg	0.020	11410011	39×56	0.02	12410011	80×80×110	0.2
5mg	0.020	11410012	39×56	0.02	12410012	80×80×110	0.2
10mg	0.025	11410013	39×56	0.02	12410013	80×80×110	0.2
20mg	0.03	11410014	39×56	0.02	12410014	80×80×110	0.2
50mg	0.04	11410015	39×56	0.02	12410015	80×80×110	0.2
100mg	0.05	11410016	39×56	0.02	12410016	80×80×110	0.2
200mg	0.06	11410017	39×56	0.02	12410017	80×80×110	0.2
500mg	0.08	11410018	39×56	0.02	12410018	80×80×110	0.2
1g	0.10	11410020	39×56	0.021	12410020	80×80×110	0.21
2g	0.12	11410021	39×56	0.022	12410021	80×80×110	0.21
5g	0.16	11410022	39×56	0.025	12410022	80×80×110	0.21
10g	0.20	11410023	39×56	0.03	12410023	80×80×110	0.21
20g	0.25	11410024	39×56	0.04	12410024	80×80×110	0.22
50g	0.3	11410025	39×56	0.07	12410025	80×80×110	0.25
100g	0.5	11410026	39×56	0.12	12410026	80×80×110	0.3
200g	1.0	11410027	45×66	0.23	12410027	80×80×110	0.4
500g	2.5	11410028	57×84	0.56	12410028	80×80×110	0.7
1kg	5.0	11410030	67×111	1.1	12410030	80×80×110	1.2
2kg	10	11410031	95×135	2.2	12410031	90×90×135	2.3
5kg	25	11410032	116×178	5.4	12410032	140×140×180	5.8
10kg	50	11410033	159×300	11.2	12410033	155×155×240	11.4
20kg	100	11410034	187×350	21.6	12410034	190×190×285	22

Weight Set 套装

Nominal Value 规格	Serial No. 订货代码	Quantity 数量	Measuring Range 量程	Package Size 包装尺寸(LxWxH)	Weight(With Packaging) 含包装重量	Stainless Steel Tweezer 不锈钢镊子	Special Brush 刷子	Wipes 擦拭布
	Aluminum Case 铝箱	Pcs/Set 只/套	g	mm	kg	pc	pc	pc
1mg-500mg	12410080	12	1.11g	172×155×67	0.2	1		
1mg-100g	12410081	21	211.11g	172×155×67	0.5	1		
1mg-200g	12410082	23	611.11g	270×220×85	1.6	1	1	1
1mg-500g	12410083	24	1111.11g	270×220×100	2.2	1	1	1
1mg-1kg	12410084	25	2111.11g	340×225×125	4.1	1	1	1
1mg-2kg	12410085	27	6111.11g	330×255×145	8.4	1	1	1
1kg-5kg	12410086	4	10000.00g	275×235×185	12.0			1
1mg-5kg	12410087	28	11111.11g		14.2	1	1	2
1mg-10kg	12410088	29	21111.11g		25.4	1	1	2
1mg-20kg	12410089	30	41111.11g		47.0	1	1	2

F1 Class Stainless Steel

F1等级不锈钢



Knob Solid Weight

圆柱形实心砝码

Nominal Value 规格	Tolerance 允差	Serial No. 订货代码	Serial No. 订货代码	Package Size 包装尺寸(Φ×h)	Weight(With Packaging) 含包装重量	Serial No. 订货代码	Package Size 包装尺寸(LxWxH)	Weight(With Packaging) 含包装重量
	(mg)	W/O Box 无盒子	ABS Box 塑盒	mm	kg	Aluminum Case 铝箱	mm	kg
1mg	0.020	10420010	11420010	39×56	0.02	12420010	80×80×110	0.2
2mg	0.020	10420011	11420011	39×56	0.02	12420011	80×80×110	0.2
5mg	0.020	10420012	11420012	39×56	0.02	12420012	80×80×110	0.2
10mg	0.025	10420013	11420013	39×56	0.02	12420013	80×80×110	0.2
20mg	0.03	10420014	11420014	39×56	0.02	12420014	80×80×110	0.2
50mg	0.04	10420015	11420015	39×56	0.02	12420015	80×80×110	0.2
100mg	0.05	10420016	11420016	39×56	0.02	12420016	80×80×110	0.2
200mg	0.06	10420017	11420017	39×56	0.02	12420017	80×80×110	0.2
500mg	0.08	10420018	11420018	39×56	0.02	12420018	80×80×110	0.2
1g	0.10	10420020	11420020	39×56	0.021	12420020	80×80×110	0.21
2g	0.12	10420021	11420021	39×56	0.022	12420021	80×80×110	0.21
5g	0.16	10420022	11420022	39×56	0.025	12420022	80×80×110	0.21
10g	0.20	10420023	11420023	39×56	0.03	12420023	80×80×110	0.21
20g	0.25	10420024	11420024	39×56	0.04	12420024	80×80×110	0.22
50g	0.3	10420025	11420025	39×56	0.07	12420025	80×80×110	0.25
100g	0.5	10420026	11420026	39×56	0.12	12420026	80×80×110	0.3
200g	1.0	10420027	11420027	45×66	0.23	12420027	80×80×110	0.4
500g	2.5	10420028	11420028	57×84	0.56	12420028	80×80×110	0.7
1kg	5.0	10420030	11420030	67×111	1.1	12420030	80×80×110	1.2
2kg	10	10420031	11420031	95×135	2.2	12420031	90×90×135	2.3
5kg	25	10420032	11420032	116×178	5.4	12420032	140×140×180	5.8
10kg	50	10420033	11420033	159×300	11.2	12420033	155×155×240	11.35
20kg	100	10420034	11420034	187×350	21.6	12420034	190×190×285	22

Weight Set

套装

Nominal Value 规格	Serial No. 订货代码	Quantity 数量	Measuring Range 量程	Package Size 包装尺寸(LxWxH)	Weight(With Packaging) 含包装重量	Stainless Steel Tweezer 不锈钢镊子	Special Brush 刷子	Wipes 擦拭布
	Aluminum Case 铝箱	Pcs/Set 只/套	g	mm	kg	pc	pc	pc
1mg-500mg	12420080	12	1.11g	172×155×67	0.2	1		
1mg-100g	12420081	21	211.11g	172×155×67	0.5	1		
1mg-200g	12420082	23	611.11g	270×220×85	1.6	1	1	1
1mg-500g	12420083	24	1111.11g	270×220×100	2.2	1	1	1
1mg-1kg	12420084	25	2111.11g	340×225×125	4.1	1	1	1
1mg-2kg	12420085	27	6111.11g	330×255×145	8.4	1	1	1
1kg-5kg	12420086	4	10000.00g	275×235×185	12.0			1
1mg-5kg	12420087	28	11111.11g		14.2	1	1	2
1mg-10kg	12420088	29	21111.11g		25.4	1	1	2
1mg-20kg	12420089	30	41111.11g		47.0	1	1	2

F1 Class Stainless Steel

F1等级不锈钢



Knob Bottom Adjustment Weight

圆柱形底部调整砝码

Nominal Value 规格	Tolerance 允差	Serial No. 订货代码	Serial No. 订货代码	Package Size 包装尺寸(Φ×h)	Weight(With Packaging) 含包装重量	Serial No. 订货代码	Package Size 包装尺寸(LxWxH)	Weight(With Packaging) 含包装重量
	(mg)	W/O Box 无盒子	ABS Box 塑盒	mm	kg	Aluminum Case 铝箱	mm	kg
1mg	0.020	10420110	11420110	39×56	0.02	12420110	80×80×110	0.2
2mg	0.020	10420111	11420111	39×56	0.02	12420111	80×80×110	0.2
5mg	0.020	10420112	11420112	39×56	0.02	12420112	80×80×110	0.2
10mg	0.025	10420113	11420113	39×56	0.02	12420113	80×80×110	0.2
20mg	0.03	10420114	11420114	39×56	0.02	12420114	80×80×110	0.2
50mg	0.04	10420115	11420115	39×56	0.02	12420115	80×80×110	0.2
100mg	0.05	10420116	11420116	39×56	0.02	12420116	80×80×110	0.2
200mg	0.06	10420117	11420117	39×56	0.02	12420117	80×80×110	0.2
500mg	0.08	10420118	11420118	39×56	0.02	12420118	80×80×110	0.2
1g	0.10	10420120	11420120	39×56	0.021	12420120	80×80×110	0.21
2g	0.12	10420121	11420121	39×56	0.022	12420121	80×80×110	0.21
5g	0.16	10420122	11420122	39×56	0.025	12420122	80×80×110	0.21
10g	0.20	10420123	11420123	39×56	0.03	12420123	80×80×110	0.21
20g	0.25	10420124	11420124	39×56	0.04	12420124	80×80×110	0.22
50g	0.3	10420125	11420125	39×56	0.07	12420125	80×80×110	0.25
100g	0.5	10420126	11420126	39×56	0.12	12420126	80×80×110	0.3
200g	1.0	10420127	11420127	45×66	0.23	12420127	80×80×110	0.4
500g	2.5	10420128	11420128	57×84	0.56	12420128	80×80×110	0.7
1kg	5.0	10420130	11420130	67×111	1.1	12420130	80×80×110	1.2
2kg	10	10420131	11420131	95×135	2.2	12420131	90×90×135	2.3
5kg	25	10420132	11420132	116×178	5.4	12420132	140×140×180	5.8
10kg	50	10420133	11420133	159×300	11.2	12420133	155×155×240	11.35
20kg	100	10420134	11420134	187×350	21.6	12420134	190×190×285	22

Weight Set

套装

Nominal Value 规格	Serial No. 订货代码	Quantity 数量	Measuring Range 量程	Package Size 包装尺寸(LxWxH)	Weight(With Packaging) 含包装重量	Stainless Steel Tweezer 不锈钢镊子	Special Brush 刷子	Wipes 擦拭布
	Aluminum Case 铝箱	Pcs/Set 只/套	g	mm	kg	pc	pc	pc
1mg-500mg	12420180	12	1.11g	172×155×67	0.2	1		
1mg-100g	12420181	21	211.11g	172×155×67	0.5	1		
1mg-200g	12420182	23	611.11g	270×220×85	1.6	1	1	1
1mg-500g	12420183	24	1111.11g	270×220×100	2.2	1	1	1
1mg-1kg	12420184	25	2111.11g	340×225×125	4.1	1	1	1
1mg-2kg	12420185	27	6111.11g	330×255×145	8.4	1	1	1
1kg-5kg	12420186	4	10000.00g	275×235×185	12.0			1
1mg-5kg	12420187	28	11111.11g		14.2	1	1	2
1mg-10kg	12420188	29	21111.11g		25.4	1	1	2
1mg-20kg	12420189	30	41111.11g		47.0	1	1	2

F1 Class Stainless Steel

F1等级不锈钢



Knob Top Adjustment Weight

圆柱形顶部调整砝码

Nominal Value 规格	Tolerance 允差	Serial No. 订货代码	Serial No. 订货代码	Package Size 包装尺寸(Φ×h)	Weight(With Packaging) 含包装重量	Serial No. 订货代码	Package Size 包装尺寸(LxWxH)	Weight(With Packaging) 含包装重量
	(mg)	W/O Box 无盒子	ABS Box 塑盒	mm	kg	Aluminum Case 铝箱	mm	kg
1mg	0.020	10420210	11420210	39×56	0.02	12420210	80×80×110	0.2
2mg	0.020	10420211	11420211	39×56	0.02	12420211	80×80×110	0.2
5mg	0.020	10420212	11420212	39×56	0.02	12420212	80×80×110	0.2
10mg	0.025	10420213	11420213	39×56	0.02	12420213	80×80×110	0.2
20mg	0.03	10420214	11420214	39×56	0.02	12420214	80×80×110	0.2
50mg	0.04	10420215	11420215	39×56	0.02	12420215	80×80×110	0.2
100mg	0.05	10420216	11420216	39×56	0.02	12420216	80×80×110	0.2
200mg	0.06	10420217	11420217	39×56	0.02	12420217	80×80×110	0.2
500mg	0.08	10420218	11420218	39×56	0.02	12420218	80×80×110	0.2
1g	0.10	10420220	11420220	39×56	0.021	12420220	80×80×110	0.21
2g	0.12	10420221	11420221	39×56	0.022	12420221	80×80×110	0.21
5g	0.16	10420222	11420222	39×56	0.025	12420222	80×80×110	0.21
10g	0.20	10420223	11420223	39×56	0.03	12420223	80×80×110	0.21
20g	0.25	10420224	11420224	39×56	0.04	12420224	80×80×110	0.22
50g	0.3	10420225	11420225	39×56	0.07	12420225	80×80×110	0.25
100g	0.5	10420226	11420226	39×56	0.12	12420226	80×80×110	0.3
200g	1.0	10420227	11420227	45×66	0.23	12420227	80×80×110	0.4
500g	2.5	10420228	11420228	57×84	0.56	12420228	80×80×110	0.7
1kg	5.0	10420230	11420230	67×111	1.1	12420230	80×80×110	1.2
2kg	10	10420231	11420231	95×135	2.2	12420231	90×90×135	2.3
5kg	25	10420232	11420232	116×178	5.4	12420232	140×140×180	5.8
10kg	50	10420233	11420233	159×300	11.2	12420233	155×155×240	11.35
20kg	100	10420234	11420234	187×350	21.6	12420234	190×190×285	22

Weight Set

套装

Nominal Value 规格	Serial No. 订货代码	Quantity 数量	Measuring Range 量程	Package Size 包装尺寸(LxWxH)	Weight(With Packaging) 含包装重量	Stainless Steel Tweezer 不锈钢镊子	Special Brush 刷子	Wipes 擦拭布
	Aluminum Case 铝箱	Pcs/Set 只/套	g	mm	kg	pc	pc	pc
1mg-500mg	12420280	12	1.11g	172×155×67	0.2	1		
1mg-100g	12420281	21	211.11g	172×155×67	0.5	1		
1mg-200g	12420282	23	611.11g	270×220×85	1.6	1	1	1
1mg-500g	12420283	24	1111.11g	270×220×100	2.2	1	1	1
1mg-1kg	12420284	25	2111.11g	340×225×125	4.1	1	1	1
1mg-2kg	12420285	27	6111.11g	330×255×145	8.4	1	1	1
1kg-5kg	12420286	4	10000.00g	275×235×185	12.0			1
1mg-5kg	12420287	28	11111.11g		14.2	1	1	2
1mg-10kg	12420288	29	21111.11g		25.4	1	1	2
1mg-20kg	12420289	30	41111.11g		47.0	1	1	2

F1 Class Stainless Steel

F1等级不锈钢



Knob Neck Adjustment Weight

圆柱形颈部调整砝码

Nominal Value 规格	Tolerance 允差	Serial No. 订货代码	Serial No. 订货代码	Package Size 包装尺寸(Φ×h)	Weight(With Packaging) 含包装重量	Serial No. 订货代码	Package Size 包装尺寸(LxWxH)	Weight(With Packaging) 含包装重量
	(mg)	W/O Box 无盒子	ABS Box 塑盒	mm	kg	Aluminum Case 铝箱	mm	kg
1mg	0.020	10420310	11420310	39×56	0.02	12420310	80×80×110	0.2
2mg	0.020	10420311	11420311	39×56	0.02	12420311	80×80×110	0.2
5mg	0.020	10420312	11420312	39×56	0.02	12420312	80×80×110	0.2
10mg	0.025	10420313	11420313	39×56	0.02	12420313	80×80×110	0.2
20mg	0.03	10420314	11420314	39×56	0.02	12420314	80×80×110	0.2
50mg	0.04	10420315	11420315	39×56	0.02	12420315	80×80×110	0.2
100mg	0.05	10420316	11420316	39×56	0.02	12420316	80×80×110	0.2
200mg	0.06	10420317	11420317	39×56	0.02	12420317	80×80×110	0.2
500mg	0.08	10420318	11420318	39×56	0.02	12420318	80×80×110	0.2
1g	0.10	10420320	11420320	39×56	0.021	12420320	80×80×110	0.21
2g	0.12	10420321	11420321	39×56	0.022	12420321	80×80×110	0.21
5g	0.16	10420322	11420322	39×56	0.025	12420322	80×80×110	0.21
10g	0.20	10420323	11420323	39×56	0.03	12420323	80×80×110	0.21
20g	0.25	10420324	11420324	39×56	0.04	12420324	80×80×110	0.22
50g	0.3	10420325	11420325	39×56	0.07	12420325	80×80×110	0.25
100g	0.5	10420326	11420326	39×56	0.12	12420326	80×80×110	0.3
200g	1.0	10420327	11420327	45×66	0.23	12420327	80×80×110	0.4
500g	2.5	10420328	11420328	57×84	0.56	12420328	80×80×110	0.7
1kg	5.0	10420330	11420330	67×111	1.1	12420330	80×80×110	1.2
2kg	10	10420331	11420331	95×135	2.2	12420331	90×90×135	2.3
5kg	25	10420332	11420332	116×178	5.4	12420332	140×140×180	5.8
10kg	50	10420333	11420333	159×300	11.2	12420333	155×155×240	11.35
20kg	100	10420334	11420334	187×350	21.6	12420334	190×190×285	22

Weight Set

套装

Nominal Value 规格	Serial No. 订货代码	Quantity 数量	Measuring Range 量程	Package Size 包装尺寸(LxWxH)	Weight(With Packaging) 含包装重量	Stainless Steel Tweezer 不锈钢镊子	Special Brush 刷子	Wipes 擦拭布
		Pcs/Set 只/套	g	mm	kg	pc	pc	pc
12420380	1mg-500mg	12	1.11	172×155×67	0.2	1		
12420381	1mg-100g	21	211.11	172×155×67	0.5	1		
12420382	1mg-200g	23	611.11	270×220×85	1.6	1	1	1
12420383	1mg-500g	24	1111.11	270×220×100	2.2	1	1	1
12420384	1mg-1kg	25	2111.11	340×225×125	4.1	1	1	1
12420385	1mg-2kg	27	6111.11	330×255×145	8.4	1	1	1
12420386	1kg-5kg	4	10000	275×235×185	12.0			1
12420387	1mg-5kg	28	11111.11		14.2	1	1	2
12420388	1mg-10kg	29	21111.11		25.4	1	1	2
12420389	1mg-20kg	30	41111.11		47.0	1	1	2

F1 Class Stainless Steel F1等级不锈钢

Lock Mirror Surface Weight 锁型抛光砝码

Nominal Value 规格	Mirror Surface(W/O Case) 抛光(无盒子)	Mirror Surface(Aluminum Case) 抛光(铝箱)	Size 尺寸(mm)
1kg	10421430M	12421430M	
2kg	10421431M	12421431M	
5kg	10421432M	12421432M	152×77×84
10kg	10421433M	12421433M	193×97×109
20kg	10421434M	12421434M	234×117×139
25kg	10421442M	12421435M	
50kg	10421435M	12421436M	



Lock Sanding Surface Weight 锁型砂光砝码

Nominal Value 规格	Sanding Surface(W/O Case) 砂光(无盒子)	Sanding Surface(Aluminum Case) 砂光(铝箱)	Size 尺寸(mm)
1kg	10421430	12421430	
2kg	10421431	12421431	
5kg	10421432	12421432	152×77×84
10kg	10421433	12421433	193×97×109
20kg	10421434	12421434	234×117×139
25kg	10421442	12421435	
50kg	10421435	12421436	

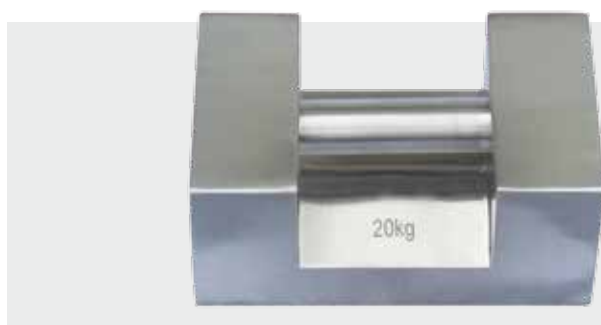

CLASS

F2



Weight 砝码

1mg-20g
Solid
实心砝码

50g-20kg
Adjustment Cavity
调整腔

 Solid Weight
实心砝码

 Bottom Adjustment
底部调整

 Top Adjustment
顶部调整

 Neck Adjustment
颈部调整

Shape 形状

1mg-500mg
Flat Polygonal Sheets
■ 片状

1g-20kg
Knob Weight
■ 圆柱体

1kg-20kg
Rectanular shape
■ 锁型

Packing 包装

Individual:
ABS Box / Aluminum Case
单只：塑盒/ 铝箱

Weight Set:
Aluminum Case
套装：铝箱

 Individual Weight
单只包装

 1mg-500mg
1mg-500mg套装

 Weight Set
套装



F2 Class Stainless Steel

F2等级不锈钢



Knob Bottom Adjustment Weight

圆柱形底部调整砝码

Nominal Value 规格	Tolerance 允差	Serial No. 订货代码	Serial No. 订货代码	Package Size 包装尺寸(Φ×h)	Weight(With Packaging) 含包装重量	Serial No. 订货代码	Package Size 包装尺寸(LxWxH)	Weight(With Packaging) 含包装重量
	(mg)	W/O Box 无盒子	ABS Box 塑盒	mm	kg	Aluminum Case 铝箱	mm	kg
1mg	0.06	10520110	11520110	39×56	0.02	12520110	80×80×110	0.2
2mg	0.06	10520111	11520111	39×56	0.02	12520111	80×80×110	0.2
5mg	0.06	10520112	11520112	39×56	0.02	12520112	80×80×110	0.2
10mg	0.08	10520113	11520113	39×56	0.02	12520113	80×80×110	0.2
20mg	0.10	10520114	11520114	39×56	0.02	12520114	80×80×110	0.2
50mg	0.12	10520115	11520115	39×56	0.02	12520115	80×80×110	0.2
100mg	0.16	10520116	11520116	39×56	0.02	12520116	80×80×110	0.2
200mg	0.20	10520117	11520117	39×56	0.02	12520117	80×80×110	0.2
500mg	0.25	10520118	11520118	39×56	0.02	12520118	80×80×110	0.2
1g	0.3	10520120	11520120	39×56	0.021	12520120	80×80×110	0.21
2g	0.4	10520121	11520121	39×56	0.022	12520121	80×80×110	0.21
5g	0.5	10520122	11520122	39×56	0.025	12520122	80×80×110	0.21
10g	0.6	10520123	11520123	39×56	0.03	12520123	80×80×110	0.21
20g	0.8	10520124	11520124	39×56	0.04	12520124	80×80×110	0.22
50g	1.0	10520125	11520125	39×56	0.07	12520125	80×80×110	0.25
100g	1.6	10520126	11520126	39×56	0.12	12520126	80×80×110	0.3
200g	3	10520127	11520127	45×66	0.23	12520127	80×80×110	0.4
500g	8	10520128	11520128	57×84	0.56	12520128	80×80×110	0.7
1kg	16	10520130	11520130	67×111	1.1	12520130	80×80×110	1.2
2kg	30	10520131	11520131	95×135	2.2	12520131	90×90×135	2.3
5kg	80	10520132	11520132	116×178	5.4	12520132	140×140×180	5.8
10kg	160	10520133	11520133	159×300	11.2	12520133	155×155×240	11.35
20kg	300	10520134	11520134	187×350	21.6	12520134	190×190×285	22

Weight Set

套装

Nominal Value 规格	Serial No. 订货代码	Quantity 数量	Measuring Range 量程	Package Size 包装尺寸(LxWxH)	Weight(With Packaging) 含包装重量	Stainless Steel Tweezer 不锈钢镊子	Special Brush 刷子	Wipes 擦拭布
	Aluminum Case 铝箱	Pcs/Set 只/套	g	mm	kg	pc	pc	pc
1mg-500mg	12520180	12	1.11	172×155×67	0.2	1		
1mg-100g	12520181	21	211.11	172×155×67	0.5	1		
1mg-200g	12520182	23	611.11	270×220×85	1.6	1	1	1
1mg-500g	12520183	24	1111.11	270×220×100	2.2	1	1	1
1mg-1kg	12520184	25	2111.11	340×225×125	4.1	1	1	1
1mg-2kg	12520185	27	6111.11	330×255×145	8.4	1	1	1
1kg-5kg	12520186	4	10000	275×235×185	12.0			1
1mg-5kg	12520187	28	11111.11		14.2	1	1	2
1mg-10kg	12520188	29	21111.11		25.4	1	1	2
1mg-20kg	12520189	30	41111.11		47.0	1	1	2

F2 Class Stainless Steel F2等级不锈钢



Knob Top Adjustment Weight 圆柱形顶部调整砝码

Nominal Value 规格	Tolerance 允差	Serial No. 订货代码	Serial No. 订货代码	Package Size 包装尺寸(Φ×h)	Weight(With Packaging) 含包装重量	Serial No. 订货代码	Package Size 包装尺寸(LxWxH)	Weight(With Packaging) 含包装重量
	(mg)	W/O Box 无盒子	ABS Box 塑盒	mm	kg	Aluminum Case 铝箱	mm	kg
1mg	0.06	10520210	11520210	39×56	0.02	12520210	80×80×110	0.2
2mg	0.06	10520211	11520211	39×56	0.02	12520211	80×80×110	0.2
5mg	0.06	10520212	11520212	39×56	0.02	12520212	80×80×110	0.2
10mg	0.08	10520213	11520213	39×56	0.02	12520213	80×80×110	0.2
20mg	0.10	10520214	11520214	39×56	0.02	12520214	80×80×110	0.2
50mg	0.12	10520215	11520215	39×56	0.02	12520215	80×80×110	0.2
100mg	0.16	10520216	11520216	39×56	0.02	12520216	80×80×110	0.2
200mg	0.20	10520217	11520217	39×56	0.02	12520217	80×80×110	0.2
500mg	0.25	10520218	11520218	39×56	0.02	12520218	80×80×110	0.2
1g	0.3	10520220	11520220	39×56	0.021	12520220	80×80×110	0.21
2g	0.4	10520221	11520221	39×56	0.022	12520221	80×80×110	0.21
5g	0.5	10520222	11520222	39×56	0.025	12520222	80×80×110	0.21
10g	0.6	10520223	11520223	39×56	0.03	12520223	80×80×110	0.21
20g	0.8	10520224	11520224	39×56	0.04	12520224	80×80×110	0.22
50g	1.0	10520225	11520225	39×56	0.07	12520225	80×80×110	0.25
100g	1.6	10520226	11520226	39×56	0.12	12520226	80×80×110	0.3
200g	3	10520227	11520227	45×66	0.23	12520227	80×80×110	0.4
500g	8	10520228	11520228	57×84	0.56	12520228	80×80×110	0.7
1kg	16	10520230	11520230	67×111	1.1	12520230	80×80×110	1.2
2kg	30	10520231	11520231	95×135	2.2	12520231	90×90×135	2.3
5kg	80	10520232	11520232	116×178	5.4	12520232	140×140×180	5.8
10kg	160	10520233	11520233	159×300	11.2	12520233	155×155×240	11.35
20kg	300	10520234	11520234	187×350	21.6	12520234	190×190×285	22

Weight Set 套装

Nominal Value 规格	Serial No. 订货代码	Quantity 数量	Measuring Range 量程	Package Size 包装尺寸(LxWxH)	Weight(With Packaging) 含包装重量	Stainless Steel Tweezer 不锈钢镊子	Special Brush 刷子	Wipes 擦拭布
	Aluminum case 铝箱	Pcs/Set 只/套	g	mm	kg	pc	pc	pc
1mg-500mg	12520280	12	1.11	172×155×67	0.2	1		
1mg-100g	12520281	21	211.11	172×155×67	0.5	1		
1mg-200g	12520282	23	611.11	270×220×85	1.6	1	1	1
1mg-500g	12520283	24	1111.11	270×220×100	2.2	1	1	1
1mg-1kg	12520284	25	2111.11	340×225×125	4.1	1	1	1
1mg-2kg	12520285	27	6111.11	330×255×145	8.4	1	1	1
1kg-5kg	12520286	4	10000	275×235×185	12.0			1
1mg-5kg	12520287	28	11111.11		14.2	1	1	2
1mg-10kg	12520288	29	21111.11		25.4	1	1	2
1mg-20kg	12520289	30	41111.11		47.0	1	1	2

F2 Class Stainless Steel

F2等级不锈钢



Knob Neck Adjustment Weight

圆柱形颈部调整砝码

Nominal Value 规格	Tolerance 允差	Serial No. 订货代码	Serial No. 订货代码	Package Size 包装尺寸(Φ×h)	Weight(With Packaging) 含包装重量	Serial No. 订货代码	Package Size 包装尺寸(LxWxH)	Weight(With Packaging) 含包装重量
	(mg)	W/O Box 无盒子	ABS Box 塑盒	mm	kg	Aluminum Case 铝箱	mm	kg
1mg	0.06	10520310	11520310	39×56	0.02	12520310	80×80×110	0.2
2mg	0.06	10520311	11520311	39×56	0.02	12520311	80×80×110	0.2
5mg	0.06	10520312	11520312	39×56	0.02	12520312	80×80×110	0.2
10mg	0.08	10520313	11520313	39×56	0.02	12520313	80×80×110	0.2
20mg	0.10	10520314	11520314	39×56	0.02	12520314	80×80×110	0.2
50mg	0.12	10520315	11520315	39×56	0.02	12520315	80×80×110	0.2
100mg	0.16	10520316	11520316	39×56	0.02	12520316	80×80×110	0.2
200mg	0.20	10520317	11520317	39×56	0.02	12520317	80×80×110	0.2
500mg	0.25	10520318	11520318	39×56	0.02	12520318	80×80×110	0.2
1g	0.3	10520320	11520320	39×56	0.021	12520320	80×80×110	0.21
2g	0.4	10520321	11520321	39×56	0.022	12520321	80×80×110	0.21
5g	0.5	10520322	11520322	39×56	0.025	12520322	80×80×110	0.21
10g	0.6	10520323	11520323	39×56	0.03	12520323	80×80×110	0.21
20g	0.8	10520324	11520324	39×56	0.04	12520324	80×80×110	0.22
50g	1.0	10520325	11520325	39×56	0.07	12520325	80×80×110	0.25
100g	1.6	10520326	11520326	39×56	0.12	12520326	80×80×110	0.3
200g	3	10520327	11520327	45×66	0.23	12520327	80×80×110	0.4
500g	8	10520328	11520328	57×84	0.56	12520328	80×80×110	0.7
1kg	16	10520330	11520330	67×111	1.1	12520330	80×80×110	1.2
2kg	30	10520331	11520331	95×135	2.2	12520331	90×90×135	2.3
5kg	80	10520332	11520332	116×178	5.4	12520332	140×140×180	5.8
10kg	160	10520333	11520333	159×300	11.2	12520333	155×155×240	11.35
20kg	300	10520334	11520334	187×350	21.6	12520334	190×190×285	22

Weight Set

套装

Nominal Value 规格	Serial No. 订货代码	Quantity 数量	Measuring Range 量程	Package Size 包装尺寸(LxWxH)	Weight(With Packaging) 含包装重量	Stainless Steel Tweezer 不锈钢镊子	Special Brush 刷子	Wipes 擦拭布
	Aluminum Case 铝箱	Pcs/Set 只/套	g	mm	kg	pc	pc	pc
1mg-500mg	12520380	12	1.11	172×155×67	0.2	1		
1mg-100g	12520381	21	211.11	172×155×67	0.5	1		
1mg-200g	12520382	23	611.11	270×220×85	1.6	1	1	1
1mg-500g	12520383	24	1111.11	270×220×100	2.2	1	1	1
1mg-1kg	12520384	25	2111.11	340×225×125	4.1	1	1	1
1mg-2kg	12520385	27	6111.11	330×255×145	8.4	1	1	1
1kg-5kg	12520386	4	10000	275×235×185	12.0			1
1mg-5kg	12520387	28	11111.11		14.2	1	1	2
1mg-10kg	12520388	29	21111.11		25.4	1	1	2
1mg-20kg	12520389	30	41111.11		47.0	1	1	2

F2 Class Stainless Steel F2等级不锈钢

Lock Mirror Surface Weight 锁型抛光砝码

Nominal Value 规格	Mirror Surface(W/O Case) 抛光(无盒子)	Mirror Surface(Aluminum Case) 抛光(铝箱)	Size 尺寸(mm)
1kg	10521430M	12521430	
2kg	10521431M	12521431	
5kg	10521432M	12521432	152×77×84
10kg	10521433M	12521433	193×97×109
20kg	10521434M	12521434	234×117×139
25kg	10521435M	12521435	
50kg	10521436M	12521436	



Lock Sanding Surface Weight 锁型砂光砝码

Nominal Value 规格	Sanding Surface(W/O Case) 砂光(无盒子)	Sanding Surface(Aluminum Case) 砂光(铝箱)	Size 尺寸(mm)
1kg	10421430	12421430	
2kg	10421431	12421431	
5kg	10421432	12421432	152×77×84
10kg	10421433	12421433	193×97×109
20kg	10421434	12421434	234×117×139
25kg	10421442	12421435	
50kg	10421435	12421436	

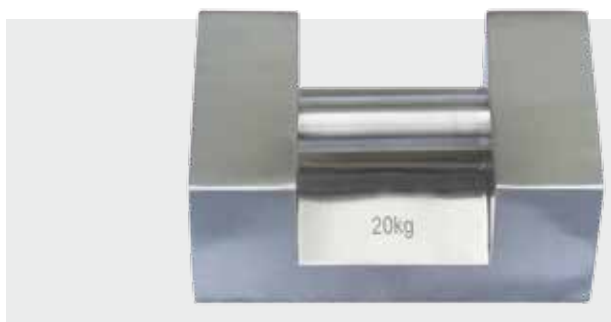

CLASS

M1



Weight
砝码

1mg-20g

Solid
实心砝码

 Solid Weight
实心砝码

50g-20kg

Adjustment Cavity
调整腔

 Bottom Adjustment
底部调整

 Top Adjustment
顶部调整

 Neck Adjustment
颈部调整

Shape
形状

1mg-500mg

Flat Polygonal Sheets
片状

 片状

1g-20kg

Knob Weight
圆柱体

 圆柱体

1kg-20kg

Rectangular shape
锁型

 锁型

Packing
包装

Individual:
ABS Box / Aluminum Case
单只: 塑盒/ 铝箱

 Individual Weight
单只包装

Weight Set:
Aluminum Case
套装: 铝箱

 1mg-500mg
1mg-500mg 套装

 Weight Set
套装



M1 Class Stainless Steel

M1等级不锈钢



Knob Bottom Adjustment Weight

圆柱形底部调整砝码

Nominal Value 规格	Tolerance 允差	Serial No. 订货代码	Serial No. 订货代码	Package Size 包装尺寸(Φ×h)	Weight(With Packaging) 含包装重量	Serial No. 订货代码	Package Size 包装尺寸(L×W×H)	Weight(With Packaging) 含包装重量
	(mg)	W/O Box 无盒子	ABS Box 塑盒	mm	kg	Aluminum Case 铝箱	mm	kg
1mg	0.20	10620110	11620110	39×56	0.02	12620110	80×80×110	0.2
2mg	0.20	10620111	11620111	39×56	0.02	12620111	80×80×110	0.2
5mg	0.20	10620112	11620112	39×56	0.02	12620112	80×80×110	0.2
10mg	0.25	10620113	11620113	39×56	0.02	12620113	80×80×110	0.2
20mg	0.3	10620114	11620114	39×56	0.02	12620114	80×80×110	0.2
50mg	0.4	10620115	11620115	39×56	0.02	12620115	80×80×110	0.2
100mg	0.5	10620116	11620116	39×56	0.02	12620116	80×80×110	0.2
200mg	0.6	10620117	11620117	39×56	0.02	12620117	80×80×110	0.2
500mg	0.8	10620118	11620118	39×56	0.02	12620118	80×80×110	0.2
1g	1.0	10620120	11620120	39×56	0.021	12620120	80×80×110	0.21
2g	1.2	10620121	11620121	39×56	0.022	12620121	80×80×110	0.21
5g	1.6	10620122	11620122	39×56	0.025	12620122	80×80×110	0.21
10g	2.0	10620123	11620123	39×56	0.03	12620123	80×80×110	0.21
20g	2.5	10620124	11620124	39×56	0.04	12620124	80×80×110	0.22
50g	3.0	10620125	11620125	39×56	0.07	12620125	80×80×110	0.25
100g	5.0	10620126	11620126	39×56	0.12	12620126	80×80×110	0.3
200g	10	10620127	11620127	45×66	0.23	12620127	80×80×110	0.4
500g	25	10620128	11620128	57×84	0.56	12620128	80×80×110	0.7
1kg	50	10620130	11620130	67×111	1.1	12620130	80×80×110	1.2
2kg	100	10620131	11620131	95×135	2.2	12620131	90×90×135	2.3
5kg	250	10620132	11620132	116×178	5.4	12620132	140×140×180	5.8
10kg	500	10620133	11620133	159×300	11.2	12620133	155×155×240	11.4
20kg	1000	10620134	11620134	187×350	21.6	12620134	190×190×285	22

Weight Set

套装

Nominal Value 规格	Serial No. 订货代码	Quantity 数量	Measuring Range 量程	Package Size 包装尺寸(L×W×H)	Weight(With Packaging) 含包装重量	Stainless Steel Tweezer 不锈钢镊子	Special Brush 刷子	Wipes 擦拭布
	Aluminum Case 铝箱	Pcs/Set 只/套	g	mm	kg	pc	pc	pc
1mg-500mg	12620180	12	1.11	172×155×67	0.2	1		
1mg-100g	12620181	21	211.11	172×155×67	0.5	1		
1mg-200g	12620182	23	611.11	270×220×85	1.6	1	1	1
1mg-500g	12620183	24	1111.11	270×220×100	2.2	1	1	1
1mg-1kg	12620184	25	2111.11	340×225×125	4.1	1	1	1
1mg-2kg	12620185	27	6111.11	330×255×145	8.4	1	1	1
1kg-5kg	12620186	4	10000	275×235×185	12.0			1
1mg-5kg	12620187	28	11111.11		14.2	1	1	2
1mg-10kg	12620188	29	21111.11		25.4	1	1	2
1mg-20kg	12620189	30	41111.11		47.0	1	1	2

M1 Class Stainless Steel

M1等级不锈钢



Knob Top Adjustment Weight

圆柱形顶部调整砝码

Nominal Value 规格	Tolerance 允差	Serial No. 订货代码	Serial No. 订货代码	Package Size 包装尺寸(Φ×h)	Weight(With Packaging) 含包装重量	Serial No. 订货代码	Package Size 包装尺寸(L×W×H)	Weight(With Packaging) 含包装重量
	(mg)	W/O Box 无盒子	ABS Box 塑盒	mm	kg	Aluminum Case 铝箱	mm	kg
1mg	0.20	10620210	11620210	39×56	0.02	12620210	80×80×110	0.2
2mg	0.20	10620211	11620211	39×56	0.02	12620211	80×80×110	0.2
5mg	0.20	10620212	11620212	39×56	0.02	12620212	80×80×110	0.2
10mg	0.25	10620213	11620213	39×56	0.02	12620213	80×80×110	0.2
20mg	0.3	10620214	11620214	39×56	0.02	12620214	80×80×110	0.2
50mg	0.4	10620215	11620215	39×56	0.02	12620215	80×80×110	0.2
100mg	0.5	10620216	11620216	39×56	0.02	12620216	80×80×110	0.2
200mg	0.6	10620217	11620217	39×56	0.02	12620217	80×80×110	0.2
500mg	0.8	10620218	11620218	39×56	0.02	12620218	80×80×110	0.2
1g	1.0	10620220	11620220	39×56	0.021	12620220	80×80×110	0.21
2g	1.2	10620221	11620221	39×56	0.022	12620221	80×80×110	0.21
5g	1.6	10620222	11620222	39×56	0.025	12620222	80×80×110	0.21
10g	2.0	10620223	11620223	39×56	0.03	12620223	80×80×110	0.21
20g	2.5	10620224	11620224	39×56	0.04	12620224	80×80×110	0.22
50g	3.0	10620225	11620225	39×56	0.07	12620225	80×80×110	0.25
100g	5.0	10620226	11620226	39×56	0.12	12620226	80×80×110	0.3
200g	10	10620227	11620227	45×66	0.23	12620227	80×80×110	0.4
500g	25	10620228	11620228	57×84	0.56	12620228	80×80×110	0.7
1kg	50	10620230	11620230	67×111	1.1	12620230	80×80×110	1.2
2kg	100	10620231	11620231	95×135	2.2	12620231	90×90×135	2.3
5kg	250	10620232	11620232	116×178	5.4	12620232	140×140×180	5.8
10kg	500	10620233	11620233	159×300	11.2	12620233	155×155×240	11.4
20kg	1000	10620234	11620234	187×350	21.6	12620234	190×190×285	22

Weight Set

套装

Nominal Value 规格	Serial No. 订货代码	Quantity 数量	Measuring Range 量程	Package Size 包装尺寸(L×W×H)	Weight(With Packaging) 含包装重量	Stainless Steel Tweezer 不锈钢镊子	Special Brush 刷子	Wipes 擦拭布
		Pcs/Set 只/套	g	mm	kg	pc	pc	pc
1mg-500mg	12620280	12	1.11	172×155×67	0.2	1		
1mg-100g	12620281	21	211.11	172×155×67	0.5	1		
1mg-200g	12620282	23	611.11	270×220×85	1.6	1	1	1
1mg-500g	12620283	24	1111.11	270×220×100	2.2	1	1	1
1mg-1kg	12620284	25	2111.11	340×225×125	4.1	1	1	1
1mg-2kg	12620285	27	6111.11	330×255×145	8.4	1	1	1
1kg-5kg	12620286	4	10000	275×235×185	12.0			1
1mg-5kg	12620287	28	11111.11		14.2	1	1	2
1mg-10kg	12620288	29	21111.11		25.4	1	1	2
1mg-20kg	12620289	30	41111.11		47.0	1	1	2

M1 Class Stainless Steel

M1等级不锈钢



Knob Neck Adjustment Weight

圆柱形颈部调整砝码

Nominal Value 规格	Tolerance 允差	Serial No. 订货代码	Serial No. 订货代码	Package Size 包装尺寸(Φ×h)	Weight(With Packaging) 含包装重量	Serial No. 订货代码	Package Size 包装尺寸(LxWxH)	Weight(With Packaging) 含包装重量
	(mg)	W/O Box 无盒子	ABS Box 塑盒	mm	kg	Aluminum Case 铝箱	mm	kg
1mg	0.20	10620310	11620310	39×56	0.02	12620310	80×80×110	0.2
2mg	0.20	10620311	11620311	39×56	0.02	12620311	80×80×110	0.2
5mg	0.20	10620312	11620312	39×56	0.02	12620312	80×80×110	0.2
10mg	0.25	10620313	11620313	39×56	0.02	12620313	80×80×110	0.2
20mg	0.3	10620314	11620314	39×56	0.02	12620314	80×80×110	0.2
50mg	0.4	10620315	11620315	39×56	0.02	12620315	80×80×110	0.2
100mg	0.5	10620316	11620316	39×56	0.02	12620316	80×80×110	0.2
200mg	0.6	10620317	11620317	39×56	0.02	12620317	80×80×110	0.2
500mg	0.8	10620318	11620318	39×56	0.02	12620318	80×80×110	0.2
1g	1.0	10620320	11620320	39×56	0.021	12620320	80×80×110	0.21
2g	1.2	10620321	11620321	39×56	0.022	12620321	80×80×110	0.21
5g	1.6	10620322	11620322	39×56	0.025	12620322	80×80×110	0.21
10g	2.0	10620323	11620323	39×56	0.03	12620323	80×80×110	0.21
20g	2.5	10620324	11620324	39×56	0.04	12620324	80×80×110	0.22
50g	3.0	10620325	11620325	39×56	0.07	12620325	80×80×110	0.25
100g	5.0	10620326	11620326	39×56	0.12	12620326	80×80×110	0.3
200g	10	10620327	11620327	45×66	0.23	12620327	80×80×110	0.4
500g	25	10620328	11620328	57×84	0.56	12620328	80×80×110	0.7
1kg	50	10620330	11620330	67×111	1.1	12620330	80×80×110	1.2
2kg	100	10620331	11620331	95×135	2.2	12620331	90×90×135	2.3
5kg	250	10620332	11620332	116×178	5.4	12620332	140×140×180	5.8
10kg	500	10620333	11620333	159×300	11.2	12620333	155×155×240	11.4
20kg	1000	10620334	11620334	187×350	21.6	12620334	190×190×285	22

Weight Set

套装

Nominal Value 规格	Serial No. 订货代码	Quantity 数量	Measuring Range 量程	Package Size 包装尺寸(LxWxH)	Weight(With Packaging) 含包装重量	Stainless Steel Tweezer 不锈钢镊子	Special Brush 刷子	Wipes 擦拭布
		Pcs/Set 只/套	g	mm	kg	pc	pc	pc
1mg-500mg	12620380	12	1.11	172×155×67	0.2	1		
1mg-100g	12620381	21	211.11	172×155×67	0.5	1		
1mg-200g	12620382	23	611.11	270×220×85	1.6	1	1	1
1mg-500g	12620383	24	1111.11	270×220×100	2.2	1	1	1
1mg-1kg	12620384	25	2111.11	340×225×125	4.1	1	1	1
1mg-2kg	12620385	27	6111.11	330×255×145	8.4	1	1	1
1kg-5kg	12620386	4	10000	275×235×185	12.0			1
1mg-5kg	12620387	28	11111.11		14.2	1	1	2
1mg-10kg	12620388	29	21111.11		25.4	1	1	2
1mg-20kg	12620389	30	41111.11		47.0	1	1	2

M1 Class Stainless Steel

M1等级不锈钢

Lock Mirror Surface Weight

锁型抛光砝码

Nominal Value 规格	Mirror Surface(W/O Case) 抛光(无盒子)	Mirror Surface(Aluminum Case) 抛光(铝箱)	Size 尺寸(mm)
1kg	10621430M	12621430M	
2kg	10621431M	12621431M	
5kg	10621432M	12621432M	152×77×84
10kg	10621433M	12621433M	193×97×109
20kg	10621434M	12621434M	234×117×139
25kg	10621435M	12621435M	
50kg	10621436M	12621436M	

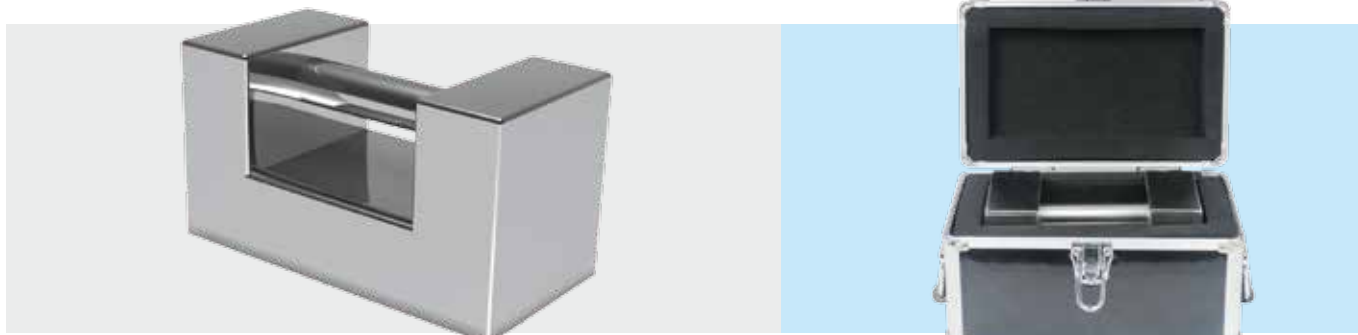

Lock Sanding Surface Weight

锁型砂光砝码

Nominal Value 规格	Sanding Surface(W/O Case) 砂光(无盒子)	Sanding Surface(Aluminum Case) 砂光(铝箱)	Size 尺寸(mm)
1kg	10621430	12621430	
2kg	10621431	12621431	
5kg	10621432	12621432	152×77×84
10kg	10621433	12621433	193×97×109
20kg	10621434	12621434	234×117×139
25kg	10621435	12621435	
50kg	10621436	12621436	

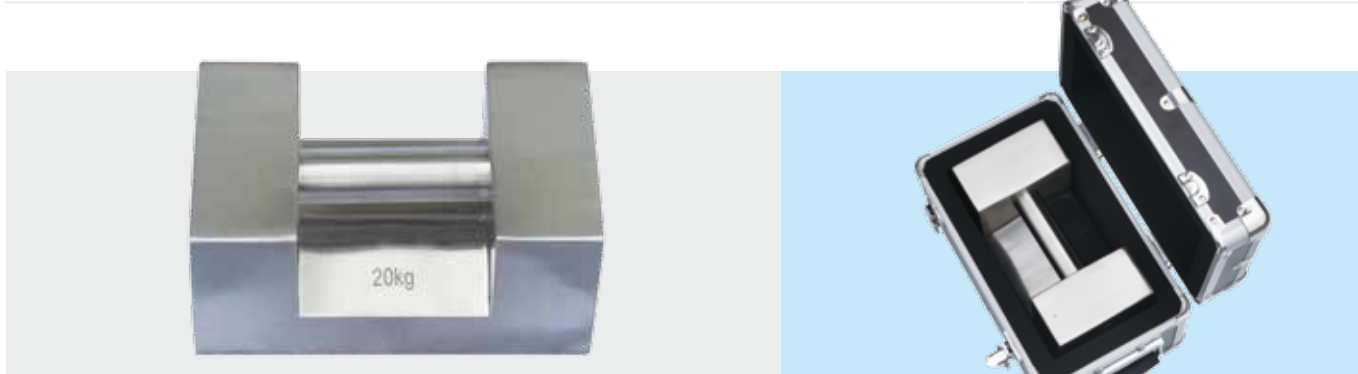

M1 Class Chromed Steel

M1等级钢制镀铬

Weight
砝码

5g-20kg

Knob Weight
圆柱形砝码

Adjustment Cavity
带调整腔

Packing
包装

Individual:
ABS Box / Aluminum Case
单只: 塑盒/ 铝箱

Weight Set:
Aluminum Case
套装: 铝箱

Individual Weight
单只包装

Weight Set
套装



M1 Class Chromed Steel

M1等级钢制镀铬



Knob Weight Bottom Adjustment

底部调整砵码

Nominal Value 规格	Tolerance 允差	Serial No. 订货代码	Serial No. 订货代码	Package Size 包装尺寸(Φ×h)	Weight(With Packaging) 含包装重量	Serial No. 订货代码	Package Size 包装尺寸(LxWxH)	Weight(With Packaging) 含包装重量
	(mg)	W/O Box 无盒子	ABS Box 塑盒	mm	kg	Aluminum Case 铝箱	mm	kg
5g	1.6	10630122	11630122	39×56	0.025	12630122	80×80×110	0.21
10g	2.0	10630123	11630123	39×56	0.03	12630123	80×80×110	0.21
20g	2.5	10630124	11630124	39×56	0.04	12630124	80×80×110	0.22
50g	3.0	10630125	11630125	39×56	0.07	12630125	80×80×110	0.25
100g	5.0	10630126	11630126	39×56	0.12	12630126	80×80×110	0.3
200g	10	10630127	11630127	45×66	0.23	12630127	80×80×110	0.4
500g	25	10630128	11630128	57×84	0.56	12630128	80×80×110	0.7
1kg	50	10630130	11630130	67×111	1.1	12630130	80×80×110	1.2
2kg	100	10630131	11630131	95×135	2.2	12630131	90×90×135	2.3
5kg	250	10630132	11630132	116×178	5.4	12630132	140×140×180	5.8
10kg	500	10630133	11630133	159×300	11.2	12630133	155×155×240	11.4
20kg	1000	10630134	11630134	187×350	21.6	12630134	190×190×285	22
50kg	2500	10630135	11630135			12630135		
100kg	5000	10630136	11630136			12630136		
200kg	10000	10630137	11630137			12630137		
500kg	25000	10630138	11630138			12630138		
1000kg	50000	10630139	11630139			12630139		
2000kg	100000	10630140	11630140			12630140		

M1 Class set

M1 钢镀铬套装

Nominal Value 规格	Serial No. 订货代码	Quantity 数量	Measuring Range 量程	Package Size 包装尺寸(LxWxH)	Weight(With Packaging) 含包装重量	Stainless Steel Tweezer 不锈钢镊子	Special Brush 刷子	Wipes 擦拭布
	Aluminum Case 铝箱	Pcs/Set 只/套	g	mm	kg	pc	pc	pc
12630181	1mg-100g	21	211.11	172×155×67	0.5	1		
12630182	1mg-200g	23	611.11	270×220×85	1.6	1	1	1
12630183	1mg-500g	24	1111.11	270×220×100	2.2	1	1	1
12630184	1mg-1kg	25	2111.11	340×225×125	4.1	1	1	1
12630185	1mg-2kg	27	6111.11	330×255×145	8.4	1	1	1
12630186	1kg-5kg	4	10000	275×235×185	12.0			1
12630187	1mg-5kg	28	11111.11		14.2	1	1	2
12630188	1mg-10kg	29	21111.11		25.4	1	1	2
12630189	1mg-20kg	30	41111.11		47.0	1	1	2

M1 Class Chromed Steel

M1等级钢制镀铬



Knob Weight Top Adjustment

顶部调整砵码

Nominal Value 规格	Tolerance 允差	Serial No. 订货代码	Serial No. 订货代码	Package Size 包装尺寸(Φ×h)	Weight(With Packaging) 含包装重量	Serial No. 订货代码	Package Size 包装尺寸(LxWxH)	Weight(With Packaging) 含包装重量
	(mg)	W/O Box 无盒子	ABS Box 塑盒	mm	kg	Aluminum Case 铝箱	mm	kg
5g	1.6	10630222	11630222	39×56	0.025	12630222	80×80×110	0.21
10g	2.0	10630223	11630223	39×56	0.03	12630223	80×80×110	0.21
20g	2.5	10630224	11630224	39×56	0.04	12630224	80×80×110	0.22
50g	3.0	10630225	11630225	39×56	0.07	12630225	80×80×110	0.25
100g	5.0	10630226	11630226	39×56	0.12	12630226	80×80×110	0.3
200g	10	10630227	11630227	45×66	0.23	12630227	80×80×110	0.4
500g	25	10630228	11630228	57×84	0.56	12630228	80×80×110	0.7
1kg	50	10630230	11630230	67×111	1.1	12630230	80×80×110	1.2
2kg	100	10630231	11630231	95×135	2.2	12630231	90×90×135	2.3
5kg	250	10630232	11630232	116×178	5.4	12630232	140×140×180	5.8
10kg	500	10630233	11630233	159×300	11.2	12630233	155×155×240	11.4
20kg	1000	10630234	11630234	187×350	21.6	12630234	190×190×285	22

M1 Class Set

M1 钢镀铬套装

Nominal Value 规格	Serial No. 订货代码	Quantity 数量	Measuring Range 量程	Package Size 包装尺寸(LxWxH)	Weight(With Packaging) 含包装重量	Stainless Steel Tweezer 不锈钢镊子	Special Brush 刷子	Wipes 擦拭布
	Aluminum Case 铝箱	Pcs/Set 只/套	g	mm	kg	pc	pc	pc
1g-100g	12630281	21	211.11	172×155×67	0.5	1		
1g-200g	12630282	23	611.11	270×220×85	1.6	1	1	1
1g-500g	12630283	24	1111.11	270×220×100	2.2	1	1	1
1g-1kg	12630284	25	2111.11	340×225×125	4.1	1	1	1
1g-2kg	12630285	27	6111.11	330×255×145	8.4	1	1	1
1kg-5kg	12630286	4	10000	275×235×185	12.0			1
1g-5kg	12630287	28	11111.11		14.2	1	1	2
1g-10kg	12630288	29	21111.11		25.4	1	1	2
1g-20kg	12630289	30	41111.11		47.0	1	1	2

M1 Class Brass

M1等级铜质烤漆



Knob Weight Bottom Adjustment

底部调整腔砝码

Nominal Value 规格	Tolerance 允差	Serial No. 订货代码	Serial No. 订货代码	Package Size 包装尺寸(Φ×h)	Weight(With Packaging) 含包装重量	Serial No. 订货代码	Package Size 包装尺寸(LxWxH)	Weight(With Packaging) 含包装重量
	(mg)	W/O Box 无盒子	ABS Box 塑盒	mm	kg	Aluminum Case 铝箱	mm	kg
1g	1.0	10650120	11650120	39×56	0.021	12650120	80×80×110	0.21
2g	1.2	10650121	11650121	39×56	0.022	12650121	80×80×110	0.21
5g	1.6	10650122	11650122	39×56	0.025	12650122	80×80×110	0.21
10g	2.0	10650123	11650123	39×56	0.03	12650123	80×80×110	0.21
20g	2.5	10650124	11650124	39×56	0.04	12650124	80×80×110	0.22
50g	3.0	10650125	11650125	39×56	0.07	12650125	80×80×110	0.25
100g	5.0	10650126	11650126	39×56	0.12	12650126	80×80×110	0.3
200g	10	10650127	11650127	45×66	0.23	12650127	80×80×110	0.4
500g	25	10650128	11650128	57×84	0.56	12650128	80×80×110	0.7
1kg	50	10650130	11650130	67×111	1.1	12650130	80×80×110	1.2
2kg	100	10650131	11650131	95×135	2.2	12650131	90×90×135	2.3
5kg	250	10650132	11650132	116×178	5.4	12650132	140×140×180	5.8
10kg	500	10650133	11650133	159×300	11.2	12650133	155×155×240	11.4
20kg	1000	10650134	11650134	187×350	21.6	12650134	190×190×285	22

M1 Brass Weight Set

M1铜质烤漆

Nominal Value 规格	Serial No. 订货代码	Quantity 数量	Measuring Range 量程	Package Size 包装尺寸(LxWxH)	Weight(With Packaging) 含包装重量	Stainless Steel Tweezer 不锈钢镊子	Special Brush 刷子	Wipes 擦拭布
	Aluminum Case 铝箱	Pcs/Set 只/套	g	mm	kg	pc	pc	pc
1g-100g	12650181	21	211.11	172×155×67	0.5	1		
1g-200g	12650182	23	611.11	270×220×85	1.6	1	1	1
1g-500g	12650183	24	1111.11	270×220×100	2.2	1	1	1
1g-1kg	12650184	25	2111.11	340×225×125	4.1	1	1	1
1g-2kg	12650185	27	6111.11	330×255×145	8.4	1	1	1
1kg-5kg	12650186	4	10000	275×235×185	12.0			1
1g-5kg	12650187	28	11111.11		14.2	1	1	2
1g-10kg	12650188	29	21111.11		25.4	1	1	2
1g-20kg	12650189	30	41111.11		47.0	1	1	2

M1 Class Brass

M1等级铜质烤漆



Knob Weight Top Adjustment

顶部调整腔砝码

Nominal Value 规格	Tolerance 允差	Serial No. 订货代码	Serial No. 订货代码	Package Size 包装尺寸(Φ×h)	Weight(With Packaging) 含包装重量	Serial No. 订货代码	Package Size 包装尺寸(LxWxH)	Weight(With Packaging) 含包装重量
	(mg)	W/O Box 无盒子	ABS Box 塑盒	mm	kg	Aluminum Case 铝箱	mm	kg
1g	1.0	10650220	11650220	39×56	0.021	12650220	80×80×110	0.21
2g	1.2	10650221	11650221	39×56	0.022	12650221	80×80×110	0.21
5g	1.6	10650222	11650222	39×56	0.025	12650222	80×80×110	0.21
10g	2.0	10650223	11650223	39×56	0.03	12650223	80×80×110	0.21
20g	2.5	10650224	11650224	39×56	0.04	12650224	80×80×110	0.22
50g	3.0	10650225	11650225	39×56	0.07	12650225	80×80×110	0.25
100g	5.0	10650226	11650226	39×56	0.12	12650226	80×80×110	0.3
200g	10	10650227	11650227	45×66	0.23	12650227	80×80×110	0.4
500g	25	10650228	11650228	57×84	0.56	12650228	80×80×110	0.7
1kg	50	10650230	11650230	67×111	1.1	12650230	80×80×110	1.2
2kg	100	10650231	11650231	95×135	2.2	12650231	90×90×135	2.3
5kg	250	10650232	11650232	116×178	5.4	12650232	140×140×180	5.8
10kg	500	10650233	11650233	159×300	11.2	12650233	155×155×240	11.4
20kg	1000	10650234	11650234	187×350	21.6	12650234	190×190×285	22

M1 Brass Weight Set

M1铜质烤漆

Nominal Value 规格	Serial No. 订货代码	Quantity 数量	Measuring Range 量程	Package Size 包装尺寸(LxWxH)	Weight(With Packaging) 含包装重量	Stainless Steel Tweezer 不锈钢镊子	Special Brush 刷子	Wipes 擦拭布
	Aluminum Case 铝箱	Pcs/Set 只/套	g	mm	kg	pc	pc	pc
1g-100g	12650281	21	211.11	172×155×67	0.5	1		
1g-200g	12650282	23	611.11	270×220×85	1.6	1	1	1
1g-500g	12650283	24	1111.11	270×220×100	2.2	1	1	1
1g-1kg	12650284	25	2111.11	340×225×125	4.1	1	1	1
1g-2kg	12650285	27	6111.11	330×255×145	8.4	1	1	1
1kg-5kg	12650286	4	10000	275×235×185	12.0			1
1g-5kg	12650287	28	11111.11		14.2	1	1	2
1g-10kg	12650288	29	21111.11		25.4	1	1	2
1g-20kg	12650289	30	41111.11		47.0	1	1	2

M1 Class Cast Iron M1等级铸铁

Cast iron weights: Each weight has an adjusting cavity located on it's side or top.
OEM or cast company logo is available.
Competitive price makes cast iron weights attractive among customers all over the world.
铸铁砝码，带调整腔，可以根据客户要求尺寸定制。

High Quality Cast Iron Weight 精铸铁砝码

Nominal Value 规格	Serial No. 订货代码
5kg	10641232
10kg	10641233
20kg	10641234

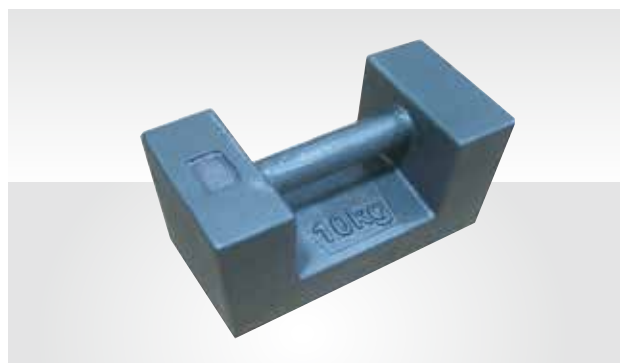

Common Quality Cast Iron Weight 普通铸铁砝码

Nominal Value 规格	Serial No. 订货代码	Shape 形状				
		Rectangular 锁型	Flat 平板型	Roller 滚筒型	Round 圆型	Cylinder 圆柱型
500g	10641428	√				
1kg	10641429	√				
2kg	10641430	√				
5kg	10641431	√				
10kg	10641432	√				
20kg	10641433	√				
25kg	10641434	√				
50kg	10641435	√				
100kg	10641436	√				
200kg	10641437	√			√	
250kg	10641438	√			√	
500kg	10641439	√	√	√	√	
1000kg	10641440	√	√	√		√
2000kg	10641441	√	√			√
5000kg	10641442		√			

Stainless Steel ODM Weight 不锈钢定制砝码

Grip Handle Weight 把手式砝码

Norminal Value 规格	5kg-50kg
Class 等级	F1/F2/M1
Packing 包装	Without Case / Aluminum Case 裸装/铝箱



Barrel Weight 水桶式砝码

Norminal Value 规格	5kg-50kg
Class 等级	F1/F2/M1
Packing 包装	Without Case / Aluminum Case 裸装/铝箱



Slotted Weight -Sanding Surface 增坨砝码（砂光）

Norminal Value 规格	1g-50kg
Class 等级	F1/F2/M1
Packing 包装	Without Case / Aluminum Case 裸装/铝箱



Slotted Weight -Mirror Surface 增坨砝码（抛光）

Norminal Value 规格	1g-50kg
Class 等级	F1/F2/M1
Packing 包装	Without Case / Aluminum Case 裸装/铝箱



Hook Weight 挂钩式砝码

Norminal Value 规格	1g-50kg
Class 等级	F1/F2/M1
Packing 包装	Without Case / Aluminum Case 裸装/铝箱



School Education Weight 教学类砝码

Norminal Value 规格	1g-50kg
Class 等级	M1/M2
Packing 包装	Without Case / Aluminum Case 裸装/铝箱



ASTM Weight 美标砝码

Norminal Value 规格	1mg-50kg
Class 等级	0/1/2/3/4/5/6/7
Packing 包装	Without Case / Aluminum Case 裸装/铝箱



Heavy Capacity Weight 大质量砝码

F1/F2/M1 CLASS

Shape : Cylindrical with ring / Flat / ODM

Adjustment Cavity

Packing : Aluminum Case / Iron Case

形状 : 圆柱形带吊环 / 方形 / 定制

带调整腔

包装 : 铝箱 / 铁箱

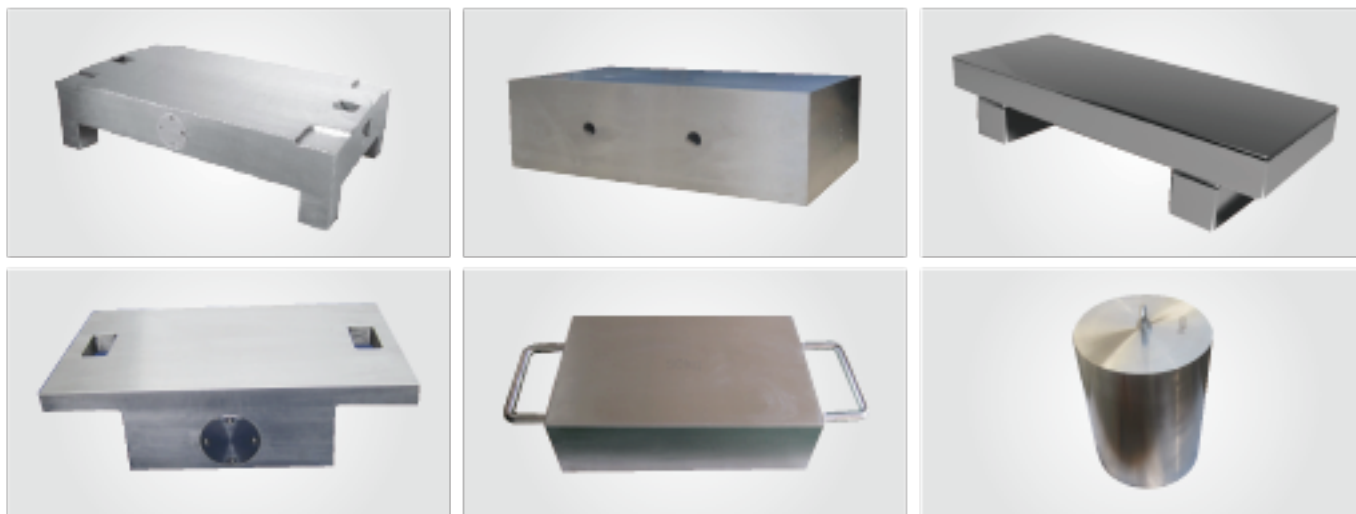

Stainless Steel F1 Class 不锈钢F1等级

Nominal Value 规格	Tolerance (mg) 允差	Aluminum Case 铝箱	Iron Box 铁箱
50kg	250	12420135	13420135
100kg	500	12420136	13420136
200kg	1000	12420137	13420137
500kg	2500	12420138	13420138
1000kg	5000	12420139	13420139
2000kg	10000	12420140	13420140

Stainless Steel F2 Class 不锈钢F2等级

Nominal Value 规格	Tolerance (mg) 允差	Aluminum Case 铝箱	Iron Box 铁箱
50kg	800	12520135	13520135
100kg	1600	12520136	13520136
200kg	3000	12520137	13520137
500kg	8000	12520138	13520138
1000kg	16000	12520139	13520139
2000kg	30000	12520140	13520140

Stainless Steel M1 Class 不锈钢M1等级

Nominal Value 规格	Tolerance (mg) 允差	Aluminum Case 铝箱	Iron Box 铁箱
50kg	2500	12620135	13620135
100kg	5000	12620136	13620136
200kg	10000	12620137	13620137
500kg	25000	12620138	13620138
1000kg	50000	12620139	13620139
2000kg	100000	12620140	13620140

Chromed Steel M1 Class 钢制镀铬M1等级

Nominal Value 规格	Tolerance (mg) 允差	Aluminum Case 铝箱	Iron Box 铁箱
50kg	2500	12630135	13630135
100kg	5000	12630136	13630136
200kg	10000	12630137	13630137
500kg	25000	12630138	13630138
1000kg	50000	12630139	13630139
2000kg	100000	12630140	13630140

Accessories 砝码附件

Individual Rectangular Weight Aluminum Box 锁型砝码铝箱

Nominal Value 规格	Serial No. 订货代码
5kg	32001050
10kg	32001051
20kg	32001052



Aluminum Box (Weight Set) 套装砝码铝箱

Nominal Value 规格	Serial No. 订货代码
1mg-500mg	32000080
1mg-100g	32000081
1mg-200g	32000082
1mg-500g	32000083
1mg-1kg	32000084
1mg-2kg	32000085
1kg-5kg	32000086



High Quality Aluminum Box (Weight Set) 套装砝码高品质铝箱

Nominal Value 规格	Serial No. 订货代码
1mg-100g	32000110
1mg-200g	32000111
1mg-500g	32000112
1mg-1kg	32000113
1mg-2kg	32000114



Serial No. 订货代码	Description 产品名称
30000001	Stainless Steel Small Tweezer 不锈钢小镊子
30000002	Stainless Steel Big Tweezer 不锈钢大镊子
30000003	Cleaning brush 砝码刷
30000004	Wipes 擦拭布
30000005	Gloves 手套



ABS Box 塑盒

Aluminum Case 铝箱

Nominal Value 规格	Serial No. 订货代码	Nominal Value 规格	Serial No. 订货代码
1mg	31000010	1mg	31000110
2mg	31000011	2mg	31000111
5mg	31000012	5mg	31000112
10mg	31000013	10mg	31000113
20mg	31000014	20mg	31000114
50mg	31000015	50mg	31000115
100mg	31000016	100mg	31000116
200mg	31000017	200mg	31000117
500mg	31000018	500mg	31000118
1g	31000020	1g	31000120
2g	31000021	2g	31000121
5g	31000022	5g	31000122
10g	31000023	10g	31000123
20g	31000024	20g	31000124
100g	31000025	100g	31000125
200g	31000026	200g	31000126
500g	31000027	500g	31000127
1kg	31000030	1kg	31000130
2kg	31000031	2kg	31000131
5kg	31000032	5kg	31000132
10kg	31000033	10kg	31000133
20kg	31000034	20kg	31000134
1mg-500mg	31000180		
1mg-5g	31000181		



Serial No. 订货代码	Description 产品名称
30000006	Weight Fork for 500g 500g砝码叉
30000007	Weight Fork for 1kg 1kg砝码叉
30000008	Weight Fork for 2kg 2kg砝码叉
30000009	Weight Fork for 5kg 5kg砝码叉
30000010	Weight Fork for 10kg 10kg砝码叉
30000011	Weight Fork for 20kg 20kg砝码叉



ACCURATE

MACHINE



The auto-load testing machine design as customer requirement: Hydraulic or electric servo power. It can be connected with computer and get testing result report in computer. Greatly improve the weighing testing production efficiency.

我司专业制造设计的衡器检测设备，可以根据客户生产需求个性化设计。如台秤的标定、重复性、线性、四角检测等，可以一键操作完成，并且通过电脑采集数据，基本实现自动化检测。

该设备可以解决衡器检测过程中劳动强度大、检测速度慢、检测流程不完整等问题，极大地提高生产工效。

MACHINE

- Body Scale Auto-load Testing Machine
- Counting Scale Auto-load Testing Machine
- Platform Scale Auto-load Testing Machine
- Hook Scale Auto-load Testing Machine
- Floor Scale Auto-load Testing Machine
- Medical Chair Scale Auto-load Testing Machine
- Forklift Truck Scale Auto-load Testing Machine
- Load Cell Creep Auto-load Testing Machine
- Load Cell Four Corners Auto-load Testing Machine
- Comparator Auto-load Testing Machine
- Auto-load Move Weight Machine
- Baby Scale Auto-load Testing Machine
- Postal Parcel Scale Auto-load Testing Machine
- Electrical Balance Auto-load Testing Machine
- Fatigue Auto-load Testing Machine

- 人体秤标定机
- 桌秤标定机
- 台秤标定机
- 吊钩秤标定机
- 小地磅标定机
- 轮椅秤标定机
- 叉车秤标定机
- 传感器蠕变测试机
- 传感器四角标定机
- 比较仪用砝码机械手
- 砝码搬运助力臂
- 婴儿秤标定机
- 邮包秤标定机
- 电子天平标定机
- 疲劳测试机

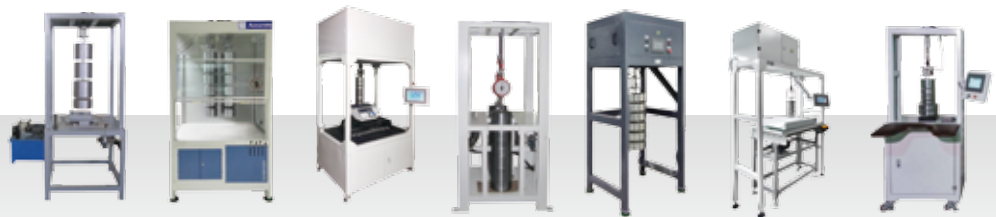



1. Serial No. 20010

Body Scale Auto-load Testing Machine

人体秤标定机

Weights Tower Material 砝码材料	Stainless Steel / Chromed Steel 不锈钢 / 钢制镀铬	
Capacity 规格	100kg-300kg	
Power System 动力	Sever Motor 伺服电机	Hydraulic 液压
Voltage 电压	220V	380V
Power 功率	0.75kw	1.5KW
Measure size (L*W*H) 尺寸 (长*宽*高)	950*650*2240mm	
Working Control 控制方式	Touch Screen + Button 触摸屏+按钮控制	



2. Serial No. 20020

Counting Scale Auto-load Testing Machine

桌秤标定机

Weights Tower Material 砝码材料	Stainless Steel 不锈钢	
Capacity 规格	3kg-60kg	
Power System 动力	Sever Motor 伺服电机	
Voltage 电压	220V	
Power 功率	0.4kw	
Measure size (L*W*H) 尺寸 (长*宽*高)	1120*720*2130mm	
Working Control 控制方式	Touch Screen + Button / Computer Control 触摸屏+按钮控制 / 电脑控制	



3.Serial No. 20030

Platform Scale Auto-load Testing Machine 台秤标定机

Weights Tower Material 砝码材料	Stainless Steel / Chromed Steel 不锈钢 / 钢制镀铬
Capacity 规格	60kg-600kg
Power System 动力	Hydraulic 液压
Voltage 电压	380V
Power 功率	1.5kw
Measure size (L*W*H) 尺寸 (长*宽*高)	1200*1000*2530mm
Working Control 控制方式	Manual Valve Controlling 手动阀控制



4.Serial No. 20040

Hook Scale Auto-load Testing Machine 吊钩秤标定机

Weights Tower Material 砝码材料	Stainless Steel / Chromed Steel 不锈钢 / 钢制镀铬
Capacity 规格	30kg-10000kg
Power System 动力	Hydraulic/ Sever Motor 液压 / 伺服电机
Voltage 电压	Hydraulic液压: 380V Sever Motor 伺服电机: 220V
Power 功率	0.75kw
Measure size (L*W*H) 尺寸 (长*宽*高)	Hydraulic液压: 850*750*2400mm Sever Motor 伺服电机: 750*550*2040mm
Working Control 控制方式	Hydraulic: Manual Valve Controlling 液压: 手动阀控制 Sever Motor: Touch Screen + Button / Computer Control 伺服电机: 触摸屏+按钮控制





5. Serial No. 20050

Floor Scale Auto-load Testing Machine 小地磅标定机

Weights Tower Material 砝码材料	Stainless Steel / Chromed Steel 不锈钢 / 钢制镀铬
Capacity 规格	500kg-6000kg
Power System 动力	Variable Frequency Motor 变频电机
Voltage 电压	380V
Power 功率	3.0kw
Measure size (L*W*H) 尺寸 (长*宽*高)	1940*1500*2710mm
Working Control 控制方式	Botton Controlling 按钮控制



6. Serial No. 20060

Medical Chair Scale Auto-load Testing Machine 轮椅秤标定机

Weights Tower Material 砝码材料	Stainless Steel / Chromed Steel 不锈钢 / 钢制镀铬
Capacity 规格	100kg-300kg
Power System 动力	Sever Motor 伺服电机
Voltage 电压	220V
Power 功率	0.75kw
Measure size (L*W*H) 尺寸 (长*宽*高)	1000*920*2290mm
Working Control 控制方式	Touch Screen + Button / Computer Control 触摸屏+按钮控制 / 电脑控制



7.Serial No. 20070

Forklift Truck Scale Auto-load Testing Machine 叉车秤标定机

Weights Tower Material 砝码材料	Stainless Steel 不锈钢 / 钢制镀铬
Capacity 规格	3000kg
Power System 动力	Sever Motor 液压
Voltage 电压	380V
Power 功率	1.5kw
Measure size (L*W*H) 尺寸 (长*宽*高)	900*700*2500mm
Working Control 控制方式	Manual Valve Controlling 手动阀控制



8.Serial No. 20080

Load Cell Creep Auto-load Testing Machine 传感器蠕变测试机

Weights Tower Material 砝码材料	Stainless Steel / Chromed Steel 不锈钢 / 钢制镀铬
Capacity 规格	0-2000kg
Power System 动力	Sever Motor 伺服电机
Voltage 电压	220V
Power 功率	0.75kw
Measure size (L*W*H) 尺寸 (长*宽*高)	950*750*2600mm
Working Control 控制方式	Touch Screen + Button / Computer Control 触摸屏+按钮控制





9. Serial No. 20090

Load Cell Four Corners Auto-load Testing Machine

传感器四角标定机

Weights Tower Material 砝码材料	Stainless Steel / Chromed Steel 不锈钢 / 钢制镀铬
Power System 动力	Hydraulic 液压
Voltage 电压	380V
Power 功率	1.5kw
Measure size (L*W*H) 尺寸 (长*宽*高)	1200*1000*2800mm
Working Control 控制方式	Manual Valve Controlling 手动阀控制



10. Serial No. 20100

Comparator Auto-load Testing Machine

比较仪用砝码机械手

Rack Material 机架材料	Aluminum/Steel 铝型材/钢型材
Capacity 规格	5-1000kg
Power System 动力	Sever Motor 伺服电机
Voltage 电压	220V
Power 功率	1.5kw
Measure size (L*W*H) 尺寸 (长*宽*高)	1500*1000*1200mm
Working Control 控制方式	Computer Control 电脑控制



11.Serial No.20110

Auto-load Move Weight Machine

砝码搬运助力臂

Max Lift Capacity (weight/Fixture) (KG) 最大提起重量 (重物 and 夹具) (KG)	80	200	300	600
Max Speed-Hand Hold mould(m/min) 最大提升速度-手动模式 (m/min)	40	30	15	7.5
Max Speed- suspended mould(m/min) 最大提升速度-悬浮模式 (m/min)	36	27	13.5	6.75
Max Lift Height (m) 最大提升高度 (m)	3.5	3.5	3.5	2
Power 额定功率	750W	1500W	2000W	2000W
Max Electricity (A) 最大电流 (A)	10A	12A	15A	15A
Voltage 主电源	Single-Phase Power 单相电 220V±10%	Single-Phase Power 单相电 220V±10%	Three-Phase Power 三相电 220V±10%	Three-Phase Power 三相电 220V±10%
Limit 限位	Hardware Limit/ Software Limit 硬件限位、软件限位			
Tools Power 工具可用电源	24VDC/0.5A 24VDC/0.5A			
Working Control 控制方式	Sever Motor (Location Control) 伺服控制 (位置控制)			
Lift Tools 提升介质	Stainless Steel Rope (φ 5.00mm) 不锈钢钢丝绳 (φ 5.00mm)			
Working Environment Tempreture 工作环境温度范围	5-55℃ 5-55℃			
Working Environment Humidity 工作环境湿度范围	35-90% No condensation 35-90% 无凝结			
Shown Accuracy 重量显示精度	± 1% Rated Weight ± 1% 额定起重量			
Noise Level 噪音	≤80dB ≤80dB			





12. Serial No. 20120

Baby Scale Auto-load Testing Machine

婴儿秤标定机

Weights Tower Material 砝码材料	Stainless Steel 不锈钢 / 钢制镀铬
Capacity 规格	0-30kg
Power System 动力	Sever Motor 伺服电机
Voltage 电压	220V
Power 功率	0.4kw
Measure size (L*W*H) 尺寸 (长*宽*高)	1450*500*2130mm
Working Control 控制方式	Touch Screen + Button / Computer Control 触摸屏+按钮控制



13. Serial No. 20130

Postal Parcel Scale Auto-load Testing Machine

邮包秤标定机

Weights Tower Material 砝码材料	Stainless Steel 不锈钢 / 钢制镀铬
Capacity 规格	0-200kg
Power System 动力	Sever Motor 伺服电机
Voltage 电压	220V
Power 功率	0.4kw
Measure size (L*W*H) 尺寸 (长*宽*高)	700X720X2030mm
Working Control 控制方式	Touch Screen + Button 触摸屏+按钮控制



14. Serial No. 20140

Electrical Balance Auto-load Testing Machine

电子天平标定机

Weights Tower Material 砝码材料	Stainless Steel 不锈钢
Capacity 规格	100g-6kg
Power System 动力	Sever Motor 伺服电机
Voltage 电压	220V
Power 功率	0.1kw
Working Control 控制方式	Computer Control 电脑



15. Serial No. 20150

Fatigue Auto-load Testing Machine

疲劳测试机

Weights Tower Material 砝码材料	Stainless Steel 不锈钢 / 钢制镀铬
Capacity 规格	ODM 根据客户要求定制
Power System 动力	Sever Motor 伺服电机
Voltage 电压	220V
Power 功率	0.75kw
Measure size (L*W*H) 尺寸 (长*宽*高)	1250X1150X1150mm
Working Control 控制方式	Touch Screen + Button 触摸屏+按钮控制

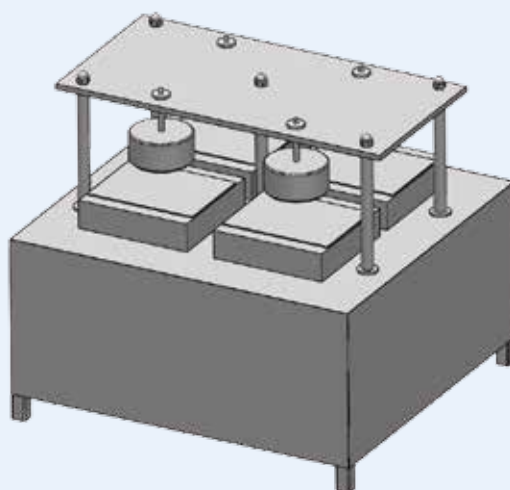



常州艾克瑞特衡器有限公司
Changzhou Accurate Weight Co.,Ltd

地址：江苏省溧阳市别桥镇兴城东路96号
A: East Xingcheng Road NO.96, Bieqiao Town,
liyong,Jiangsu, China(213300)

T: 86-519-87876188 F: 86-519-87876388

E: sales@accurate.cc

www.accurate.cc

